



USER MANUAL

THERMAL IMAGER
KT-510 • KT-520 • KT-525
KT-530 • KT-550



USER MANUAL

THERMAL IMAGER KT-510 • KT-520 • KT-525 KT-530 • KT-550

**SONEL S.A.
Wokulskiego 11
58-100 Świdnica
Poland**

Version 1.02 19.09.2024



KT Thermal Imagers comply with current EU directives related to electromagnetic compatibility and safety.

All products of Sonel S.A. are manufactured in accordance with Quality Management System which is approved to ISO 9001 for the design, manufacturing and servicing.

Due the continuous development of our products, we reserve the right to introduce changes and improvements in the thermal imaging camera and in the software described in this manual without prior notice.

Copyrights

© Sonel S.A. 2024. All rights reserved. This manual may not be copied, reproduced, translated or transferred to any electronic carriers or in machine-readable form, in whole or in part, without the prior written consent of Sonel S.A.

CONTENTS

| | | |
|----------|--|-----------|
| 1 | Introduction | 6 |
| 2 | Safety | 7 |
| 3 | Description of the camera | 9 |
| 3.1 | The camera body | 9 |
| 3.2 | Turning the camera on/off and the standby mode | 10 |
| 3.3 | Arrangement of information on the screen | 10 |
| 3.4 | Gallery | 11 |
| 3.5 | Photo editing | 13 |
| 3.6 | Pull-up menu | 14 |
| 4 | Observation | 15 |
| 4.1 | Image modes | 15 |
| 4.2 | Focus adjustment | 16 |
| 4.2.1 | Manual focus | 16 |
| 4.2.2 | Touch focus | 16 |
| 4.2.3 | Semi-auto focus | 17 |
| 4.2.4 | Continuous auto focus | 17 |
| 4.3 | Digital zoom | 17 |
| 5 | Capturing and saving images | 18 |
| 5.1 | Taking images | 18 |
| 5.2 | Panorama stitching | 19 |
| 5.3 | Super-resolution | 20 |
| 5.4 | Timed shooting | 20 |
| 6 | Recording and storing infrared videos | 21 |
| 6.1 | Video recording | 21 |
| 6.2 | Timed video recording | 21 |
| 7 | Image analysis | 22 |
| 7.1 | Temperature measurement parameters | 22 |
| 7.1.1 | Emissivity | 22 |
| 7.1.2 | Palette | 23 |
| 7.2 | Real-time analysis | 25 |
| 7.2.1 | Adding/deleting analysis objects | 25 |
| 7.2.2 | Changing the size of the analysis object | 26 |
| 7.2.3 | Linear analysis object | 26 |
| 7.2.4 | Graphic stroke | 27 |
| 7.2.5 | Difference temperature analysis | 27 |
| 7.2.6 | LEVEL/SPAN | 28 |
| 7.2.7 | File browsing | 29 |
| 7.3 | Thermal image analysis | 31 |
| 7.3.1 | Image editing | 31 |
| 7.3.2 | Image zoom | 32 |
| 7.3.3 | Creating a PDF | 32 |
| 7.3.4 | Video playback | 33 |
| 7.4 | Isotherms | 35 |
| 8 | Settings | 36 |

| | | |
|-----------|--|-----------|
| 8.1 | Search | 36 |
| 8.2 | Temperature measurement range | 36 |
| 8.3 | Temperature alarm | 37 |
| 8.4 | Image marks | 38 |
| 8.5 | Image watermark | 39 |
| 8.6 | Key assist | 39 |
| 8.7 | Ledger management | 40 |
| 8.8 | Task management | 41 |
| 8.9 | AI voice | 42 |
| 8.10 | Unit switch | 43 |
| 8.11 | Save parameters | 43 |
| 8.12 | Laser ranging | 43 |
| 8.13 | Report parameters | 43 |
| 8.14 | Preference settings | 43 |
| 8.15 | Password lock | 43 |
| 8.16 | Shutdown and sleep | 43 |
| 8.17 | Wi-Fi | 44 |
| 8.18 | Network connections | 44 |
| 8.19 | Bluetooth | 46 |
| 8.20 | General | 46 |
| 8.20.1 | Check for update | 46 |
| 8.20.2 | Storage | 46 |
| 8.20.3 | Date and time | 46 |
| 8.20.4 | Language | 47 |
| 8.20.5 | Synchronous data | 47 |
| 8.20.6 | Format SD card | 47 |
| 8.20.7 | Recovery | 47 |
| 8.20.8 | Lens recognition | 47 |
| 9 | Port connection | 48 |
| 9.1 | USB port | 48 |
| 10 | SD card | 49 |
| 10.1 | Installing SD card in the camera | 49 |
| 10.2 | Removing SD card | 49 |
| 11 | Replacing the lens | 50 |
| 12 | Power supply and battery charging | 51 |
| 12.1 | Using AC adapter | 51 |
| 12.2 | Battery power supply | 51 |
| 12.3 | Charging batteries | 51 |
| 12.4 | Charging the battery in the external battery charger | 52 |
| 12.5 | General rules of using Lithium (Li-Ion) batteries | 53 |
| 13 | Troubleshooting | 54 |
| 14 | Specifications | 55 |
| 15 | Cleaning and maintenance | 56 |
| 16 | Service and storage | 56 |
| 17 | Dismantling and disposal | 57 |

18 Optional accessories.....57
19 Manufacturer58
20 Exemplary emissivity coefficient values.....59

1 Introduction

Thank you for purchasing our thermal imager.

KT series imagers are modern, high-quality, easy and safe to use measuring devices. The infrared detector allows to capture high-quality, fully radiometric thermal images. Our products combine high-quality measurement parameters with an innovative and intuitive interface to create an intelligent solution in the field of thermal imaging.

The product is designed for professional infrared temperature measurement. The infrared detector of high sensitivity and resolution provides clearer infrared image and higher accuracy of temperature measurement. The operating system, large-size screen and detachable lens make the product powerful and easy to use. Visible light and infrared image can be captured synchronously and the key observation positions can be displayed in PIP or MIF.

Please acquaint yourself with this manual to improve your daily work with the device, and to avoid measuring errors and prevent possible problems related to operation of the imager.



Camera operation and available options may vary depending on the version of the camera. This manual describes the operation based on the highest available camera configuration.

2 Safety

Before you proceed to operate the camera, acquaint yourself thoroughly with the present manual and observe the safety regulations and specifications defined by the manufacturer.

- Any application that differs from those specified in the present manual may result in a damage to the device and constitute a source of danger for the user.
- The camera must not be used in rooms where special conditions are present e.g. fire and explosion risk.
- It is forbidden to use damaged or malfunctioning camera and is partially or fully out of order.
- In case the camera is not used for a long time, its battery should be removed.
- It is not allowed to use the camera with half-closed or opened battery cover and do not use any other power adapter than the one supplied with the camera.
- Repairs may be carried out only by an authorised service point.
- Please charge the battery with the method described in this manual and follow the charging procedure and precautions. Improper battery charging will cause heating, damage and even physical injury.
- Do not try to open or disassemble the battery at any time. Once the battery leaks and the spill enters the human eye, wash the eyes with clean water immediately and take medical care.

KT series Thermal Imagers are designed to measure and record the images in the infrared. The camera is constructed in a manner which gives you maximum performance and safety at work, however the following precautions must be adhered to at all times (in addition to any advised precautions applicable at the relevant work site or work area):

- Keep the camera steady during operation.
- Do not use the camera in ambient temperatures exceeding its operation and storage temperature ranges.
- **Do not direct the camera toward very high intensity radiation sources such as the sun, lasers or welding arcs etc.**
- Do not expose the camera to dust and moisture. When operating the device near water, ensure that it is adequately guarded against splashes.
- Cover the lens when not using the camera.
- When the camera is not in use or is to be transported, ensure that the unit and its accessories are stored in the protective carry case.
- Do not obstruct the holes in the camera's body.
- Do not re-switch on the imager before 30 seconds after switching it off and do not remove the battery when the imager is on.
- Do not throw, knock or shake intensely the camera and its components in order to avoid the damage.
- Do not attempt to open the imager's body, as this action will void the warranty.
- Keep the SD memory card for the exclusive use of the camera.
- During operation, if the camera is to be moved from hot/cold place to cold/hot place, e.g. from inside/outside to outside/inside of a room, switch the imager off and leave it in the new workplace for 20 minutes, then turn it on and start normal operation with an accurate temperature measurement. Sudden and rapid changes in ambient temperature may cause fault temperature measurement and even damage camera's IR detector.

- FPA calibration (FPA – Focal Plane Array): in order to ensure accurate temperature measurement, the FPA detector was calibrated in different temperature points. After switching the imager on, it performs auto calibration procedure every once in a while. During the calibration, for about 1 second, **the device does not respond to user's activity**, during this time the sound of a shutter clicking twice is heard. Additionally, calibration can be performed manually at any time.
- During imager operation its housing temperature increases and it's a normal phenomenon.
- Do not use soluble or similar liquids on the device and cables, which may cause damage to the device.
- Please observe the following measures when wiping this device:
 - Non-optical surface: use a clean soft cloth to wipe the non-optical surface of the thermographic camera when necessary.
 - Optical surface: when using the thermographic camera, please avoid polluting the optical surface of the lens, especially avoid touching the lens with your hands, because the sweat on your hands will leave traces on the lens glass and may corrode the optical coating on the glass surface. When the surface of the optical lens is polluted, use special lens paper to wipe it carefully.
- Do not place the battery in a high temperature or near a high-temperature object.
- Do not short circuit the positive and negative poles of the battery.
- Do not expose the battery to moisture or water.



WARNING

- **Laser locator installed in the camera may be dangerous to eyes, in case of direct contact!**
- **DO NOT DIRECTED THE LASER BEAM TOWARDS OTHER PERSONS OR ANIMALS!**
- **Please note that the laser beam may reflect off shiny surfaces.**
- **AFTER TURNING THE CAMERA ON, IT PERFORMS INTERNAL TEST, DURING WHICH, FOR FEW SECONDS, LASER POINTER IS BEING TURNED ON AS WELL. AFTER TURNING THE CAMERA ON, UNTIL IT REACHES THE POINT OF BEING FULLY OPERATIONAL IT IS FORBIDDEN TO AIM IT AT HUMAN AND ANIMALS!!**



NOTE!

- The thermal imager has no parts that could be repaired or modified by its user. Never attempt to dismantle or modify the device. Opening up the unit invalidates the warranty.
- Use only accessories listed in this manual. Using other accessories does not ensure proper operation of the camera and may cause its damage.



Due to the continuous development of the device, the design of the display and its certain features may be slightly different than presented in this manual.

3 Description of the camera

3.1 The camera body

External parts of the camera body:



- 1 Laser pointer
- 2 IR lens
- 3 Tripod socket
- 4 Trigger button (autofocus)
- 5 Trigger button (freeze / save image)
- 6 Battery
- 7 LED flashlight
- 8 Visual image lens
- 9 Type-C microUSB connector
- 10 SD card slot



- 11 Microphone
- 12 Gallery (view stored photos/videos)
- 13 „C” button (programmable)
- 14 Laser ranging button
- 15 Speaker
- 16 Display
- 17 Joystick
- 18 Return button
- 19 Power On/Off button
- 20 LED charging indicator

Further on in this document, every reference to '[number in brackets]', refers to the camera description presented in the table and drawings above.

3.2 Turning the camera on/off and the standby mode

To switch on the camera, press and hold **on/off** button [19] for around 2 seconds. A splash screen will be displayed, followed by the self-test procedure of the device. When the procedure is completed, the camera is ready to be used, and real time infrared image mode is on.



Short pressing the **on / off** button at working camera will turn off the screen and the camera will switch into a power saving mode (standby mode). A second press of **on / off** button will resume the camera to its normal operation.

To switch off the camera completely, press and hold down **on/off** button, until following information appears on the screen: (POWER OFF?). The camera will then be switched off.

Press **OK** to turn off the camera or **Cancel** to cancel the switch off procedure.

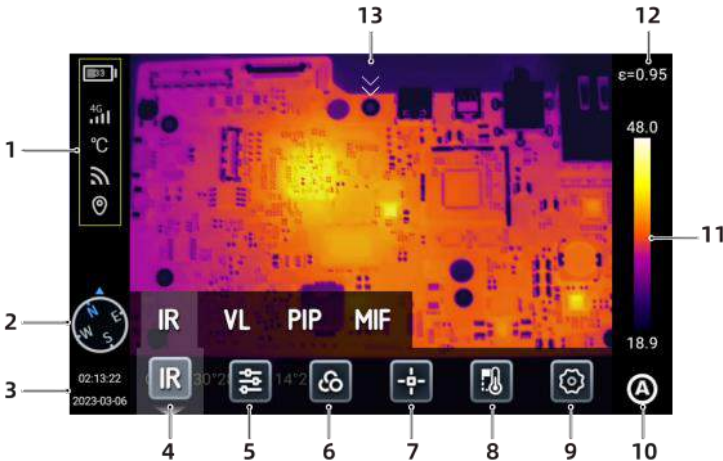
3.3 Arrangement of information on the screen



1. **Status bar.** Battery capacity, WiFi, 4G network (support some models), location.
2. **Compass information.** Go to **Settings ► Image Tags** to turn on/ff, or long press  in the real-time interface to go to Image Tags to turn on/off.
3. **Time and date.** Go to **Settings ► General ► Date & Time**, or long press  in the real-time interface to go to Date & Time interface.
4. **Image mode.** Infrared, visible light, MIF, PIP.
5. **Temperature measurement parameters.** Set the reflected temperature, atmospheric temperature, relative humidity, target distance, atmospheric transmissivity, etc.
6. **Palette.** Set and add custom colors.
7. **Analysis target.** Set the analysis target, such as the point, line, circle, rectangle, outline and temperature difference.
8. **Isotherm.** Upper isotherm, lower isotherm and isotherm within the range.
9. **Settings.** Conduct system settings.
10. **LEVEL SPAN mode.** Switch between automatic, semi-automatic and manual modes through the buttons or touch screen.
11. Switch the basic colors and custom colors in real time.
12. **Emissivity.** Set the emissivity based on the target.
13. **Shortcut menu.** Slide down the touch screen in the main preview interface to go to the Shortcut menu.

3.4 Gallery

1

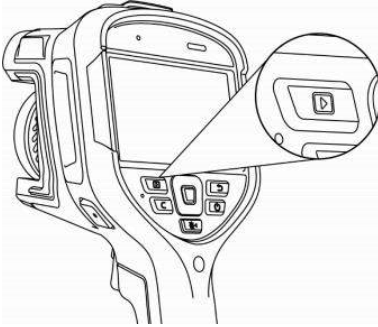

Press the **Gallery** button on the device body.

2

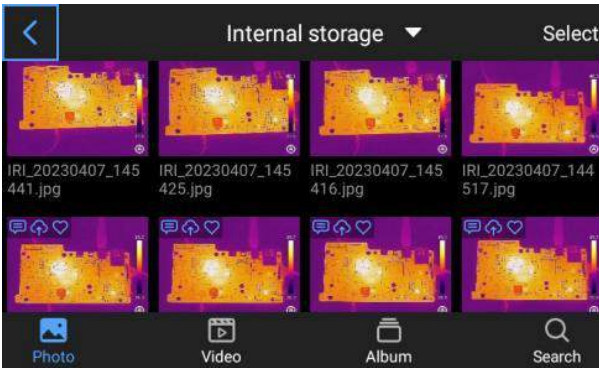

You may directly enter the file browser.

3

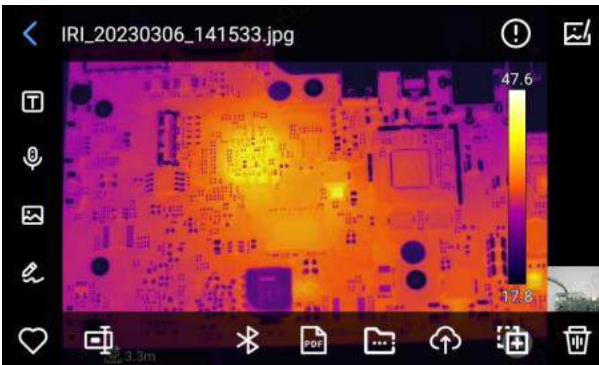

Touch and select the image to view and edit it.

In the Image Preview:

- click any image to enter the Image Edit interface,
- click any area outside the menu to preview the current infrared image in full screen.



add the current photo to your Favorites.



edit the name of the current photo. The device supports text recognition, keyboard input and voice input.



view the detailed information of the current photo.



add text notes to the current photo.



add voice notes to the current photo.



add visible light notes to the current photo.



add scribbling notes to the current photo.

add or change the analysis object, change the isotherm and change the temperature difference between two points.



transfer the current photo via Bluetooth.



make a PDF report of the current photo.



move the current photo to the specified album folder.



upload the current photo to the cloud server.



move the current photo to other storage path.

delete the current photo.

Click on the **visible light picture** in the lower right corner to preview the visible light picture corresponding to the current infrared image on the large screen.

3.5 Photo editing

This function is to edit the saved photos, including photo analysis, thermometric analysis, parameter modification, photo outline, isotherm, temperature difference, etc.

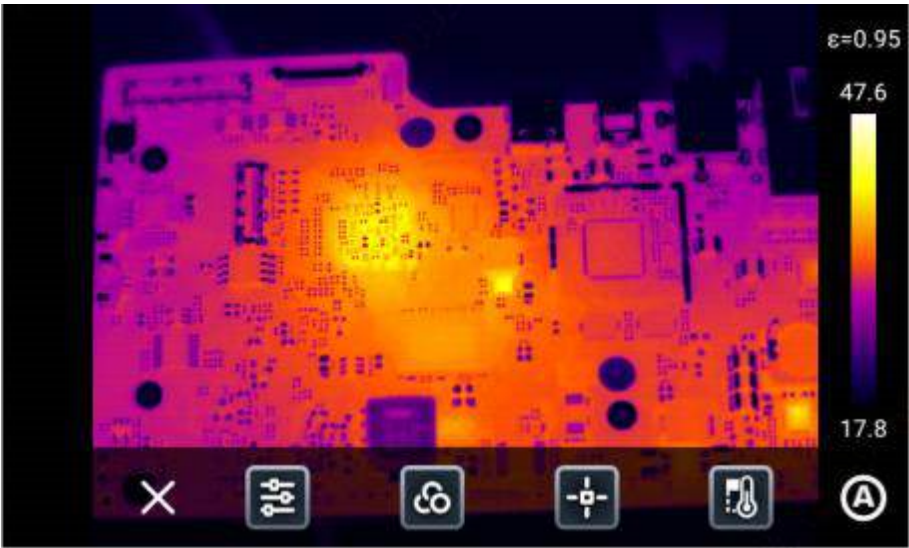

Click [X] or press the [Back] button on the device to exit the edit menu and back to the real-time preview interface.

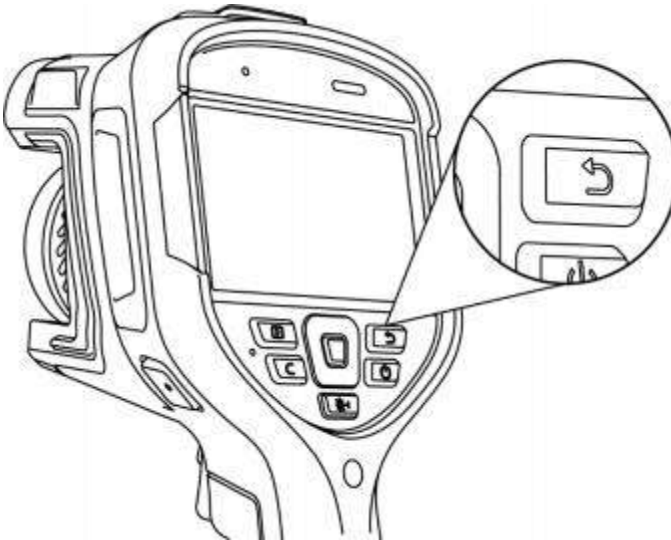

3.6 Pull-up menu

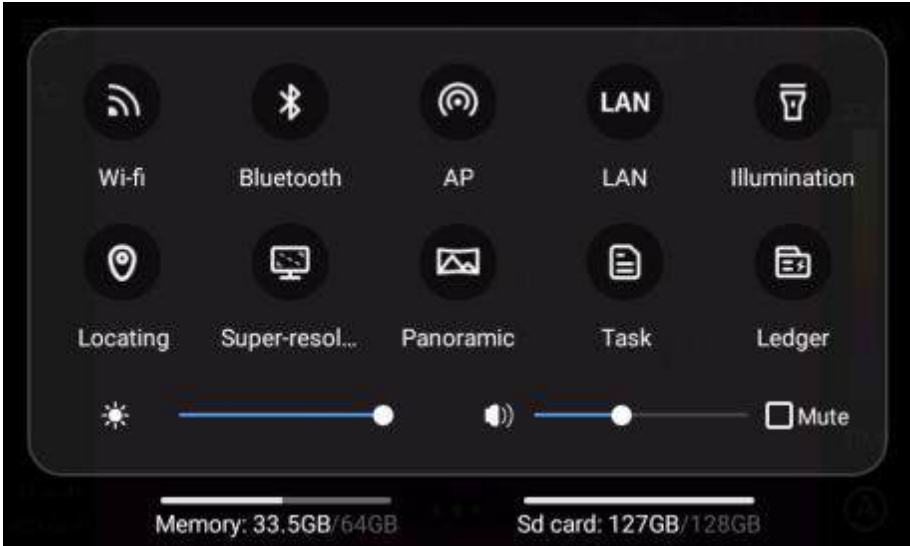

In the real-time image mode, click or slide up the icon at the bottom of the screen to pop up a shortcut menu. You may view the storage capacity of local memory or SD card and perform some quick operations, including brightness, volume, Bluetooth, Wi-Fi, laser, panoramic stitching, and super-resolution settings.

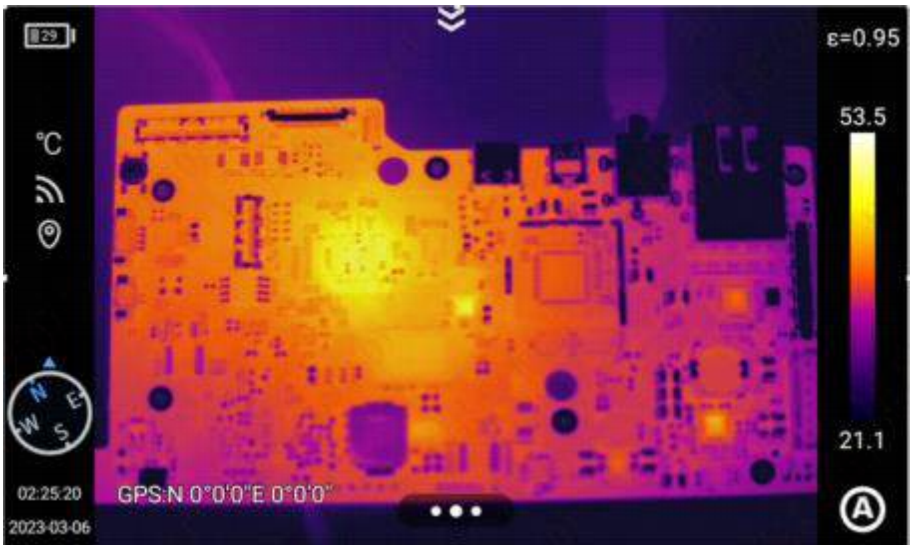

4 Observation

4.1 Image modes

The camera captures both thermal and the visual images. Use touchscreen to set the displayed image mode.

There are four modes available.

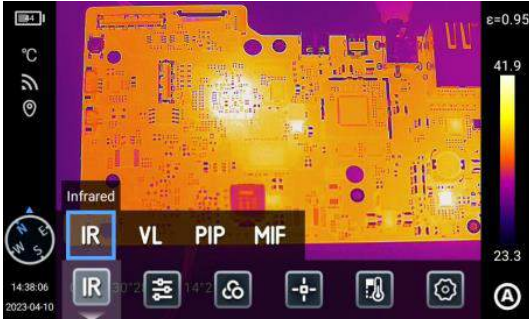

IR – infrared image.

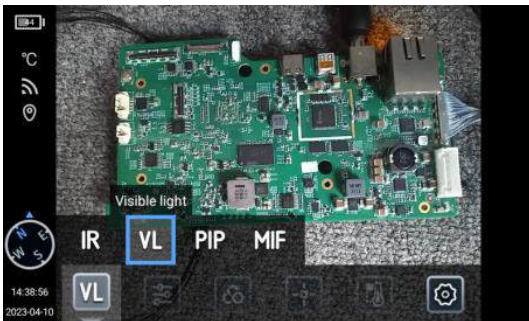

VL – visual image.

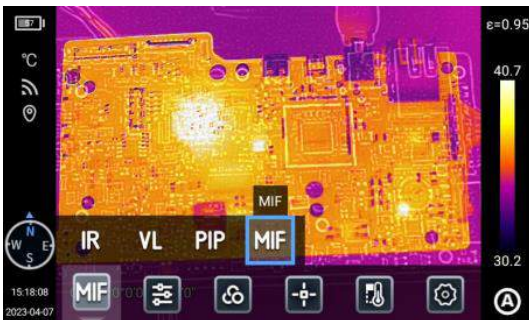

MIF – infrared image combined with visual image.

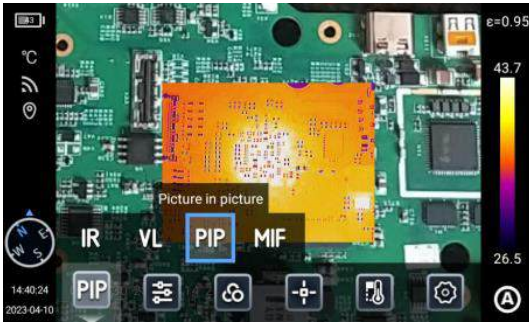

PIP – picture in picture – both infrared and visual images are displayed.

4.2 Focus adjustment

There are two focus modes: image contrast focus and laser focus.

4.2.1 Manual focus

Manually rotate the [Focusing ring] to conduct manual focus and keep the image in the observation interface is clear.



4.2.2 Touch focus

In the real-time preview interface, tap the screen to focus.

4.2.3 Semi-auto focus

Press the auxiliary trigger button to turn on focus, and the image will sharpen automatically.

- Go to **Settings ► Focus Mode**, set the corresponding focus mode (laser focus and image focus) and press the [Focus] button in the real-time preview interface to realize auto focus.
- When the image focus is selected, press the [Focus] button in the real-time image interface to realize fast focus based on the scene.
- When the image focus is selected, press the [Focus] button in the real-time image interface to display laser points and realize fast focus.

Laser focus

This function is recommended for ranging of targets that can effectively reflect the light in non-strong light exposure (such as the white paper, cable, indoor scenes). Ranging of targets that cannot reflect the light or directly absorb the light or lessen the light is not recommended (such as the transparent glass, sky, etc.).

Image contrast focus

This function enables the thermographic camera to focus the target by comparing the image brightness and contrast parameters in the observation interface to keep the image in the observation interface clear.

4.2.4 Continuous auto focus

- The thermographic camera automatically focuses the target based on the changes of the observation interface to keep the image in the observation interface clear, which is suitable for use when the thermographic camera is still.



- Auto focus shall be turned off when moving the thermographic camera, otherwise the normal use of the device will be affected.
 - Manual focus cannot be performed during auto focus.
- Go to **Settings ► Save Parameters** and enable **Continuous Auto Focus** to realize continuous and fast focus.

4.3 Digital zoom

Touch the screen with two fingers to zoom in/out to view the image details.

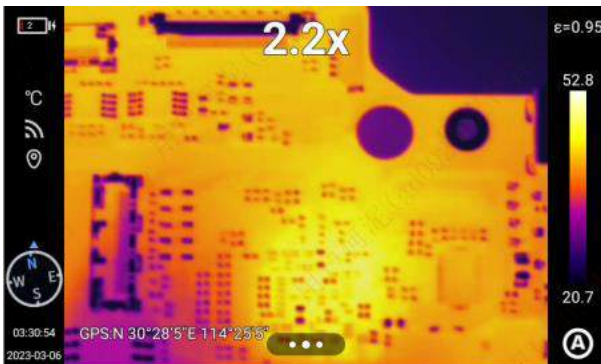

5 Capturing and saving images



- Thermal image is saved in "extended jpeg format". Thanks to that it can be viewed in all image browsers and graphics software (stored preview image will be viewed in those cases). In addition, all the information related to the thermogram is stored in one single extended jpeg file as well: temperature of each and every pixel of thermal image, voice annotation and image marks.
- Editing thermal image in software other than Sonel ThermoAnalyze software will result in losing all of the thermographic data.
- If there is not enough space to save a file on SD card or when a saving error occurs, proper information will be displayed on screen.
- Saved thermal image file name is **IRIxxxx.jpg** (where xxxxx are digits). Additionally a separate file with a visual image is saved (as **VISxxxx.jpg**, where xxxxx is the same number as in its corresponding thermal image file name). Both files must be placed in the same folder if the visual image is to be used for an analysis in Sonel ThermoAnalyze program.

5.1 Taking images

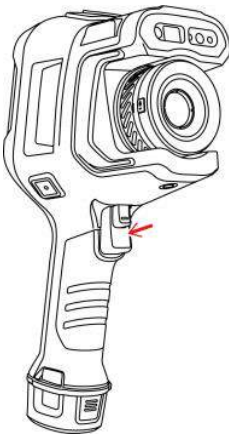

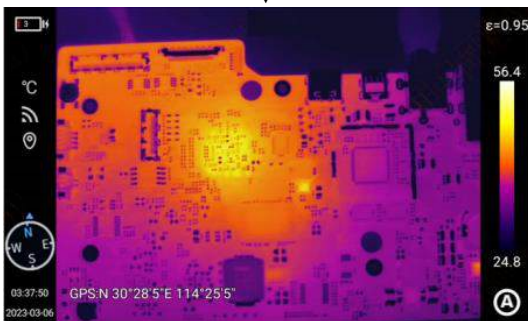

- Go to **Settings ► Photo Mode** and click **Photo** to go to **Single Frame** and select the corresponding photo mode, and then back to the main interface to adjust the imaging to the clearest state.
- Press the trigger button. The image gets frozen as shown in the figure.



5.2 Panorama stitching

Stitch two or more photos taken by the device into one panoramic photo to keep the details of the original images and provide better image of the scene.

In real-time image interface, slide down from the top of the screen to pop up the shortcut menu. Touch to open  and the device automatically backs to the main interface and enters "Panoramic" mode, and click  or  to select the photo mode and stitching will be completed after photos are taken.

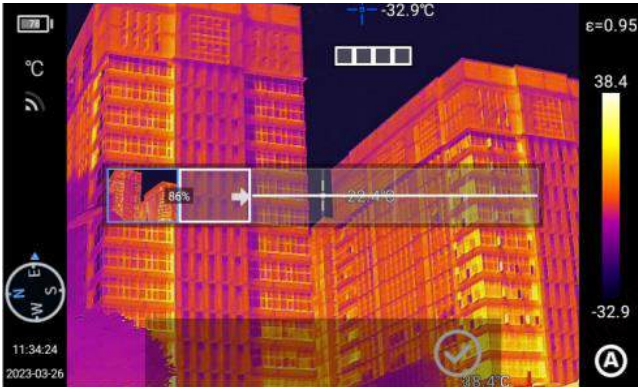

 Horizontal shooting

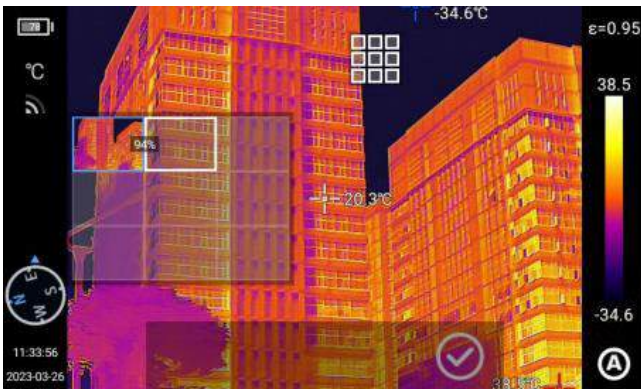

 Gridview shooting

5.3 Super-resolution

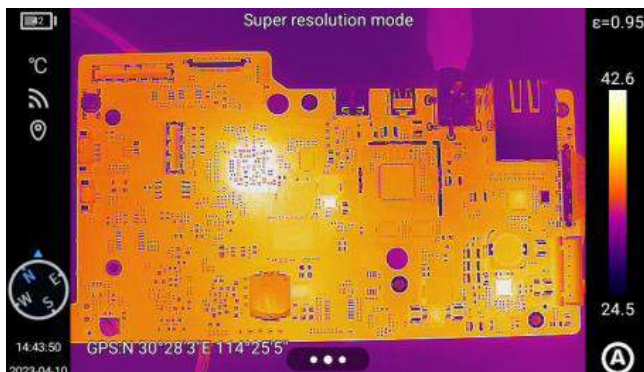

Zoom in the original image to a high resolution image that can be edited. In the real-time image interface, slide down from the top of the screen to pop up the shortcut menu and click **Super-Resolution** to enter the Super-Resolution mode.

5.4 Timed shooting

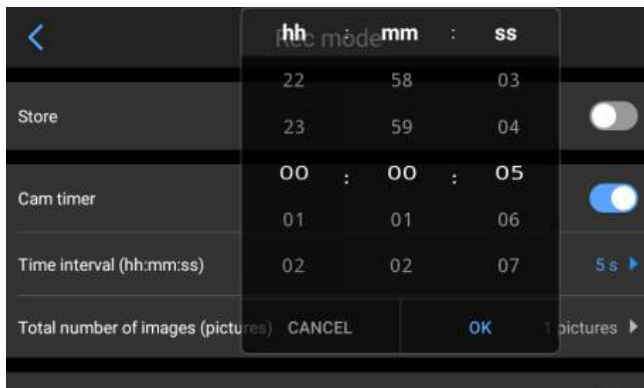

Go to **Settings ▶ Photo Mode** and select **Timed Photo** to set the interval and total number of photos. Press the **Back** button to go back to the real-time preview interface, and press **[Photo]** to take a photo and save the target scene.

6 Recording and storing infrared videos

6.1 Video recording

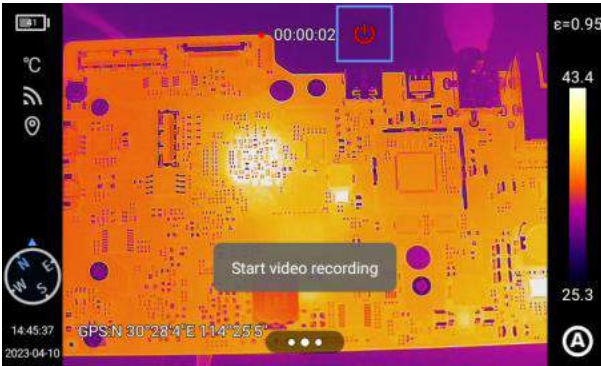

Go to **Settings ► Video Mode**. Touch to start **Video Recording** and press the **Back** button to go back to the real-time preview interface. Press **[Trigger Button]** to record the current target scene and press **[Trigger Button]** again to end recording.

6.2 Timed video recording

Go to **Settings ► Video Mode** and select **Timed Video Recording** to set the latency and duration. Press the **Back** button to go back to the real-time preview interface, and press **[Trigger Button]** to start video recording.



Latency.

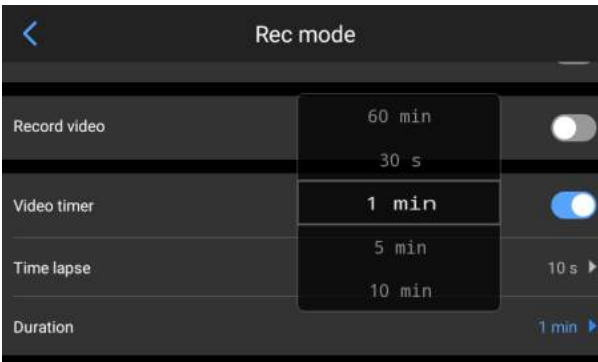

Duration.

7 Image analysis

7.1 Temperature measurement parameters

The temperature measurement parameters include: emissivity, reflected temperature, atmospheric temperature, relative humidity, target distance, optical transmittance and dew point.

Click **M** in the real-time interface to go to the secondary menu and change the parameters as demanded.

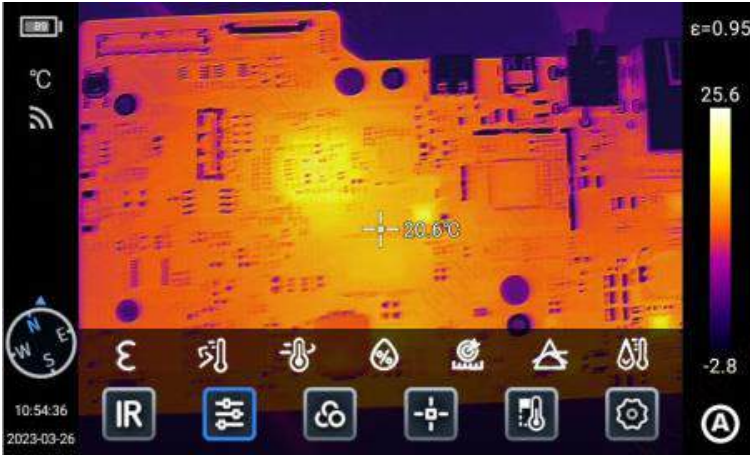

7.1.1 Emissivity

Users can set the emissivity based on the target material to ensure the temperature measurement accuracy.

Click **E** to go to the emissivity settings and select **Materials** and **User Defined**. Slide to change the values within 0.01...1.00, and touch other areas or press **[Back]** to exit and save.



Reflected temperature: When there is a high-temperature target in the scene and the emissivity of the observed target is low, and the observed target reflects the high-temperature target, the reflected temperature needs to be set. The reflected temperature shall be set at the temperature of the high-temperature target. Users can change the parameters (-40...~2,000) based on the actual conditions.

Atmospheric temperature: The atmospheric temperature of the current observation environment. Users can change the parameters based on the actual conditions, and the range is -40...2,000.

Relative humidity: Users can change the parameters based on the actual conditions, and the range is 0...100.

Target distance: The distance between the observation target and the thermographic camera. Users can set the distance parameters as demanded. Users can set the close-up, distant and general distance based on the actual conditions, and the range is 0.1...1,000.

Optical transmittance: The transmittance of the germanium glass between the thermographic camera and the observed target, and the range is 1...100.



Dew point: The temperature required for the vaporous water in the current ambient air to condense into liquid water. This temperature shall be calculated with the corresponding formula and cannot be changed.

7.1.2 Palette

Users can select different colors for different application scenarios.

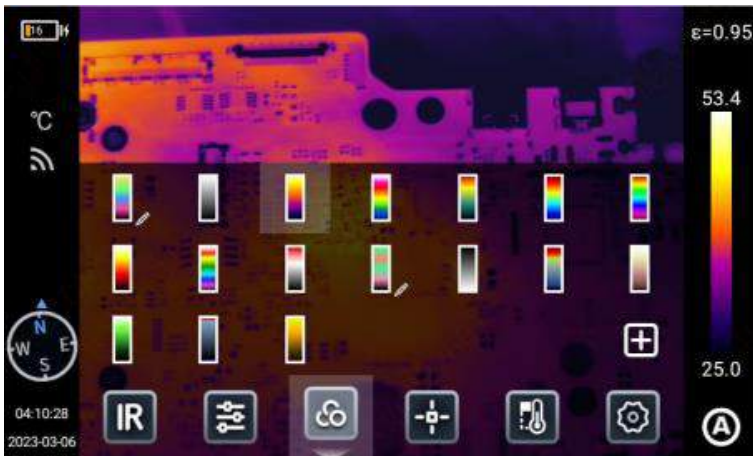
- Click the palette area on the right of the screen in real-time image status to pop up the palette options, and select the color for the scene (the options vary for some models).
- Long touch to move and adjust the color.



- Click  to create custom colors.
- In real-time image mode, click  in the color options interface to go to the palette adding interface. The image on the left automatically maps the effect based on the settings.
- Two color codes are displayed by default to map the colors of low temperature to high temperature from the bottom to top. Select the first color code and zoom in by default.

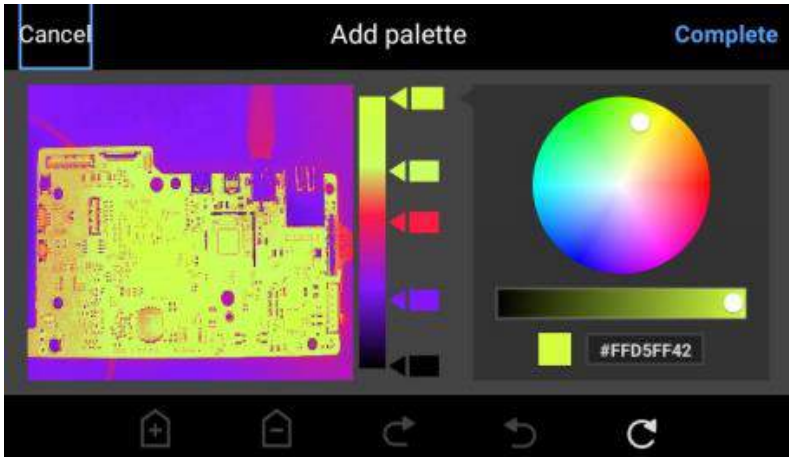

7.2 Real-time analysis

7.2.1 Adding/deleting analysis objects

- Click  at the bottom of the screen in real-time image status to open the analysis object menu interface.

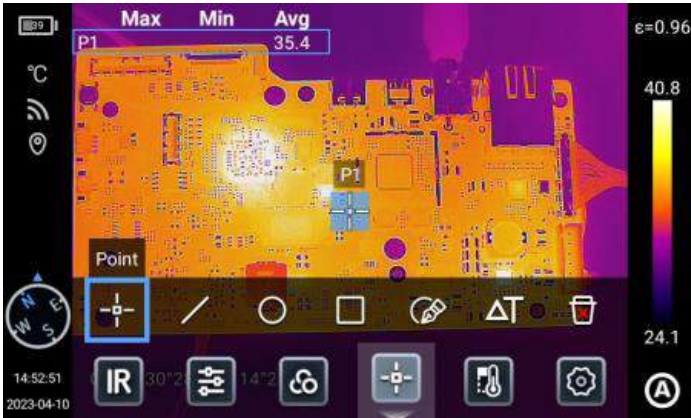

- This device supports the temperature measurement of various analysis objects, such as the dot, line, circle and rectangle, and supports the customized display of the maximum temperature, the minimum temperature and the average temperature.
- Long touch any analysis object on the screen and the system will automatically pop up the analysis object editing page.
 - **Temperature mark:** Maximum temperature, minimum temperature, average temperature.
 - **Emissivity:** The emissivity of the analysis object.
 - **Area/Length:** Enable the laser ranging function to obtain the target distance to analyze the area or length of the analysis object.
 - **Center:** Center the analysis object.
 - **Delete:** Delete the current analysis object.

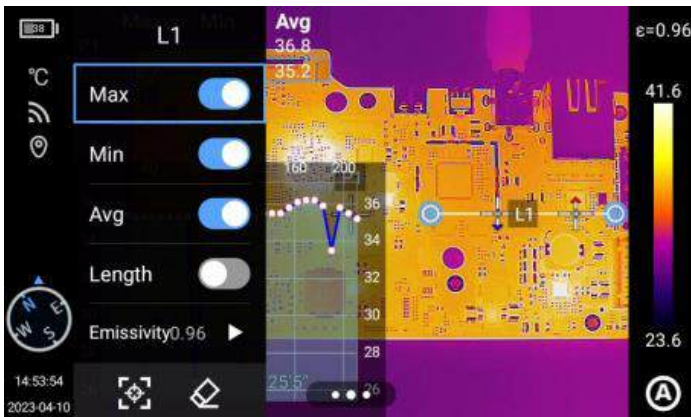

7.2.2 Changing the size of the analysis object



- Touch to select the line, circle, rectangle or polygon analysis object and the selected points will be marked blue.
- Move any point to change the area of the analysis object.

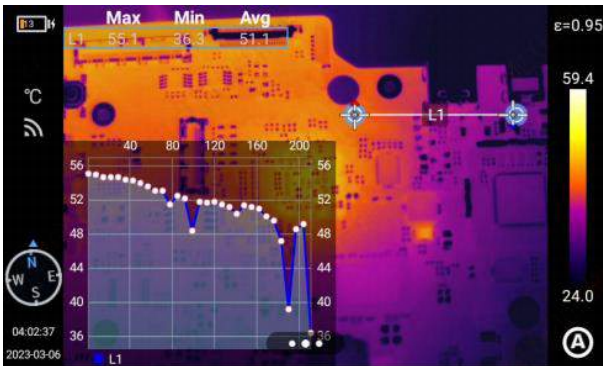

7.2.3 Linear analysis object

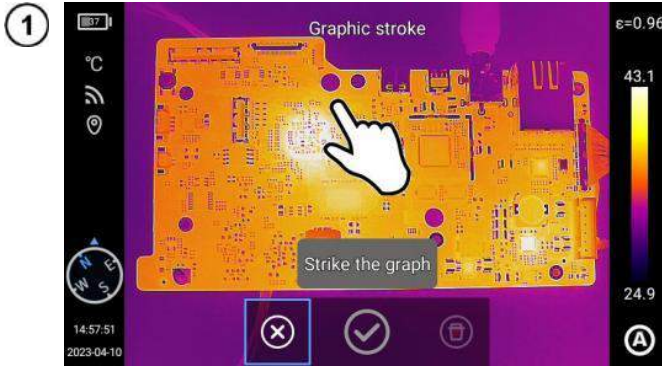

- Add a line analysis object and select to display the temperature trend of it.

7.2.4 Graphic stroke



Click  to go to image outline and manually draw the interested target outline, and click  to complete. You can also analyze the selected object.

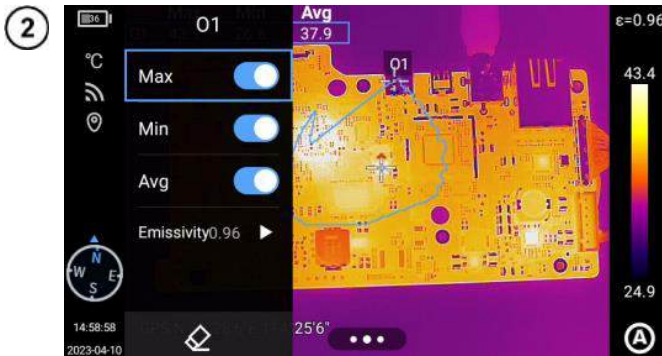

Long press the outline object to pop up the object menu.

- **Temperature mark:** Maximum temperature, minimum temperature, average temperature.
- **Emissivity:** The emissivity of the analysis object.
- **Delete:** Delete the current analysis object.

7.2.5 Difference temperature analysis

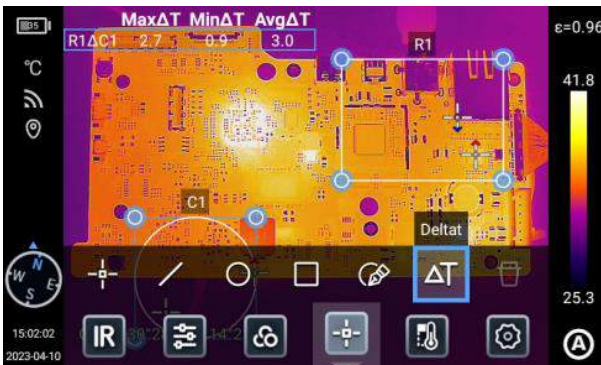

- Add at least two analysis objects.
- Click the temperature difference button ΔT under the object label to activate the temperature difference mode.
- In order to exit the temperature difference analysis, enter the shortcut menu-temperature difference and click the ΔT icon.

7.2.6 LEVEL/SPAN

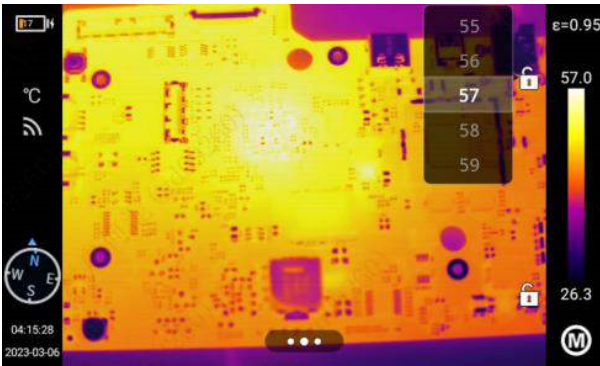
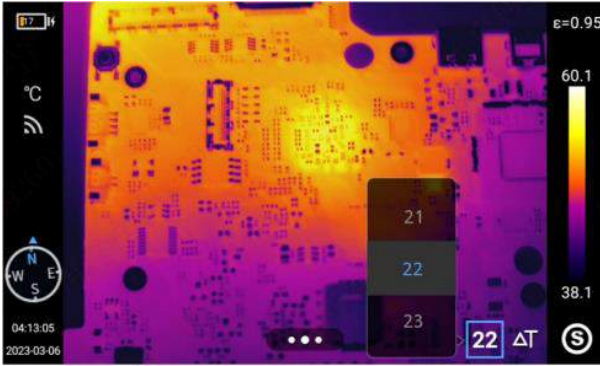

- Click **(A)**, **(M)** and **(S)** in the real-time preview status to switch among semi-auto [S], manual [M] and automatic [A].
- When level/span is in semi-auto mode, adjust ΔT value with the "Up button" or "Down button" in the five-way button or set the ΔT value by sliding the screen, and the image dimming changes synchronously.
 $\Delta T = T_{max} - T_{min}$.
- When level/span is in manual mode, adjust the "level" with the "Up button" or "Down button" in the five-way button. The "Up button" can also increase the T_{max} and T_{min} value and the "Down button" can reduce the T_{max} and T_{min} value. The image dimming changes synchronously.
- Click the maximum temperature or minimum temperature value on the color bar to pop up the value options to select the appropriate maximum or minimum temperature value. The image dimming changes synchronously.

7.2.7 File browsing

①

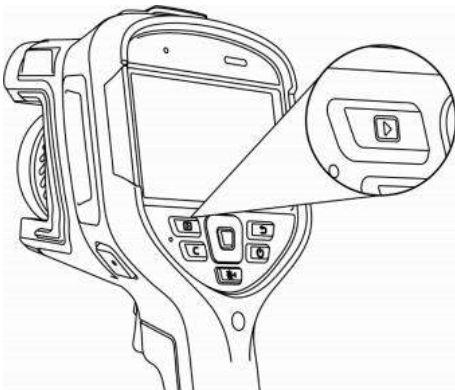

Press [**Gallery**] button on the device to go to the gallery preview interface.

②

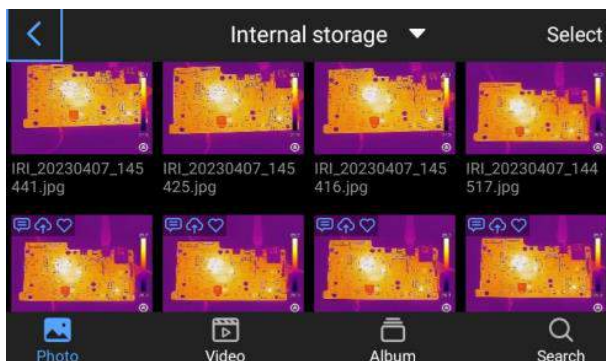

Click **Select** at the upper right corner to select images to transfer via Bluetooth, generate a PDF report, upload to the cloud disk, add to the album, cut and delete.

3

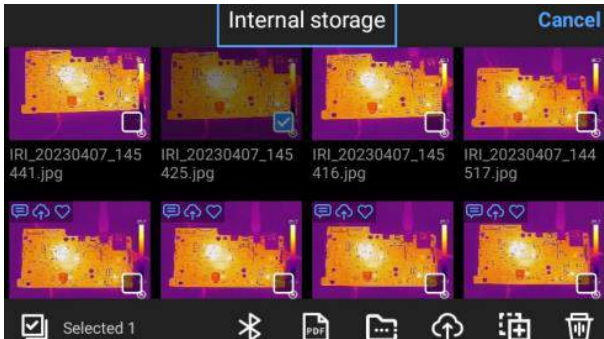

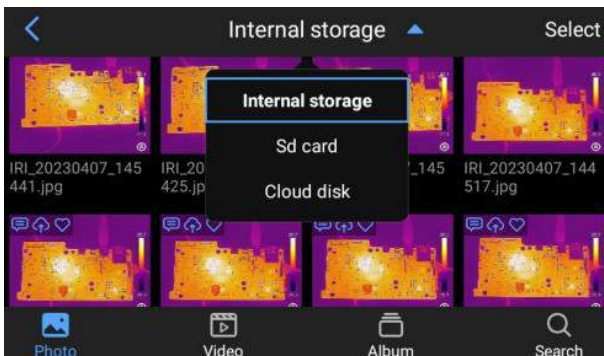

Select local, SD card (the device can identify the SD card only after the SD card installed) or cloud disk (the cloud disk will display after login) to display the files in the corresponding path.

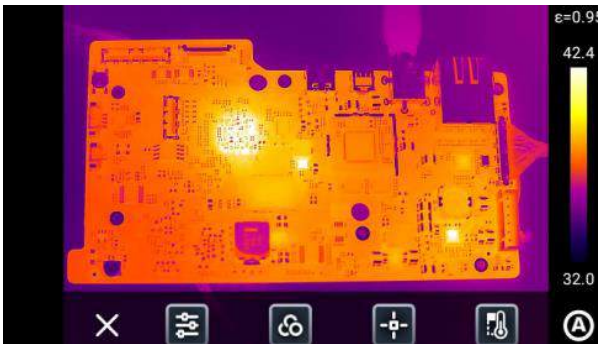
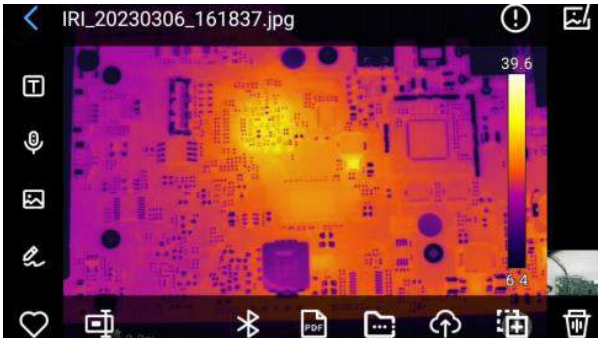

7.3 Thermal image analysis

7.3.1 Image editing



- Click any photo in the photo preview interface to go to the photo editing interface.
- You can add text, voice, visible light and scribbling notes to the current photo.
- You can add the current photo to "Favorites", rename it, transfer via Bluetooth and generate a pdf report.
- Click  to add or change the analysis object, change the isotherm, change the temperature difference and change the temperature measurement parameters of the current photo.

7.3.2 Image zoom

In image editing mode, touch the screen with two fingers and spread the fingers to zoom in the photo and fold the fingers to zoom out the photo. When the infrared image is zoomed in, slide on the screen with one finger to move the image.

7.3.3 Creating a PDF

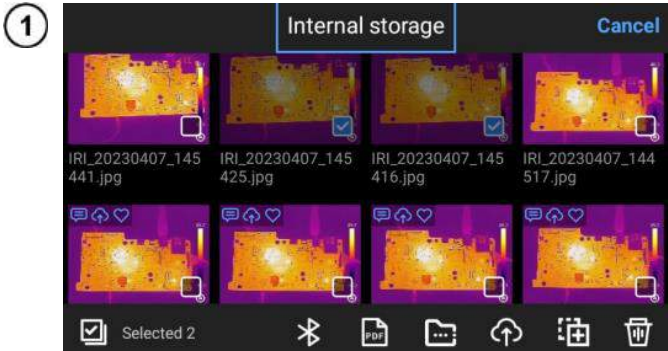

- Press **[Gallery]** button on the device to go to the gallery preview interface.
- Click the **Select** button. You can select 9 image information at will, as shown in the figure.

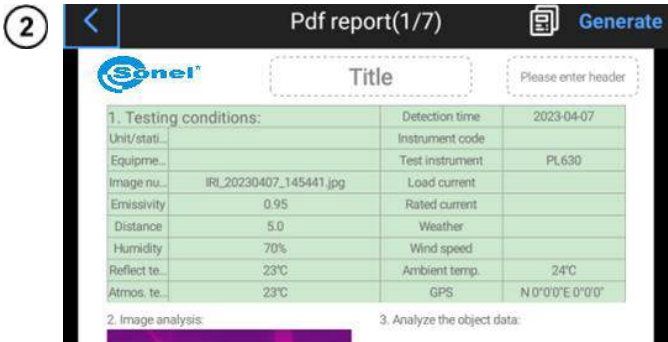

- Click the **PDF** button below to generate a PDF preview file.

7.3.4 Video playback

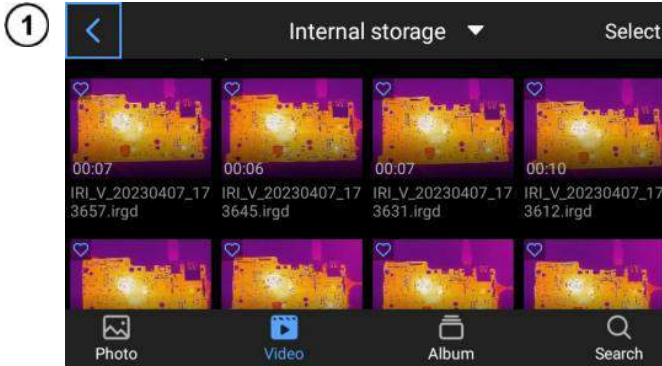

- Press the **Gallery** button to enter the gallery browsing interface, and click **Video** to enter the video interface.

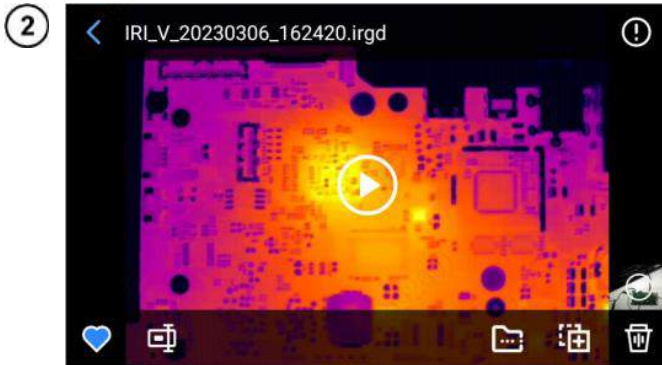

- Tap the **play** button in the center of the screen to start playing the film.
- Tap the screen to display the short film playback panel.
- To pause the video during playback, tap the **pause** button at the bottom of the screen.

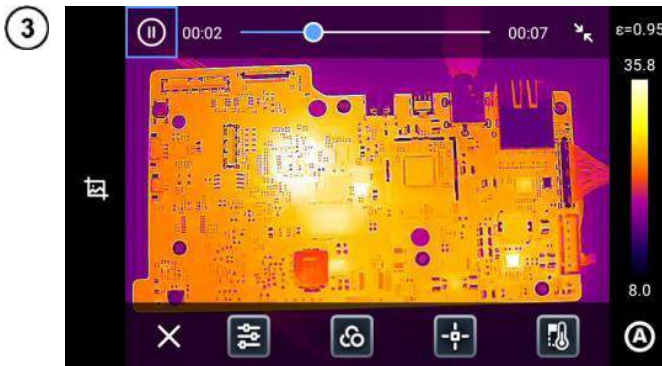

- You can change the analysis object, isotherm, temperature difference and temperature measurement parameters of the video (only support videos in IRGD format).

4



- Click **Album** to go to the album gallery, and **Favorites**, **My Tasks** and the albums created by the user will display.

5

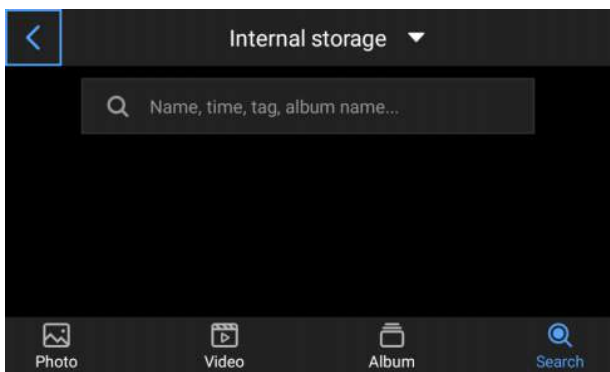



- Click "Search" to go to the album interface and enter the photo name, time and tag to search for the corresponding file.

7.4 Isotherms



The manual/semi-automatic mode does not support isotherms.

Click the shortcut menu  at the bottom of the interface and click .

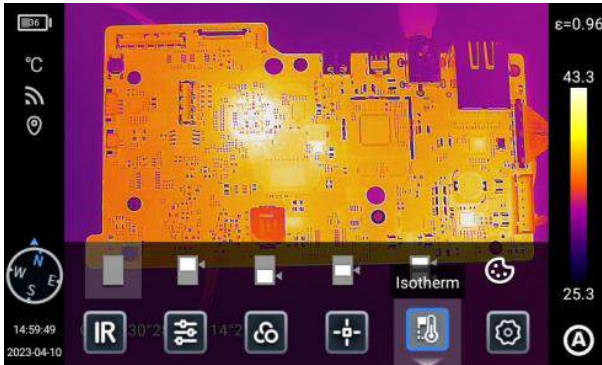

High isotherm real-time video image mode.



Low isotherm real-time video image mode.



Intra-field isotherm real-time video image mode.



Extra-field isotherm real-time video image mode.



Turn off the isotherm display.

8 Settings

In the real-time video interface, click the **Settings** button .

8.1 Search

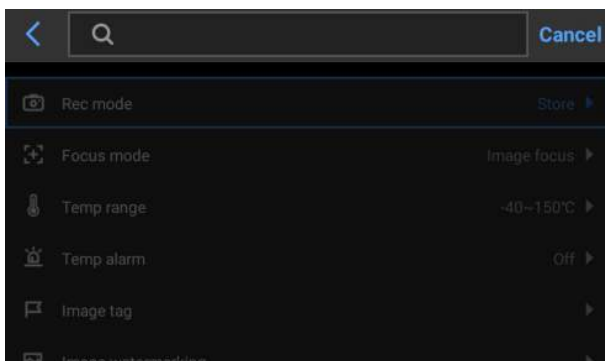

Click the "search box" at the upper right corner and search for the functions to be set.

8.2 Temperature measurement range

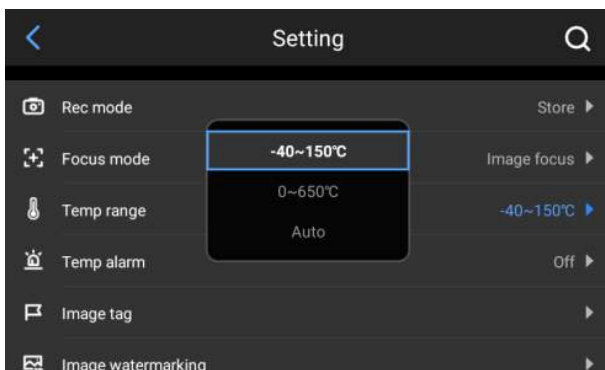

Go to **Settings ▶ Temperature Measurement Range** to pop up the selection box. Users can select the appropriate temperature measurement range for the target.

8.3 Temperature alarm

The **alarm temperature thresholds** contain high temperature and low temperature.

The **alarm temperature value** is the value of the currently set temperature measurement range.

Turn on the **high temperature alarm** switch to set the alarm temperature threshold (e.g. 35.6°C) as required. Return to the real-time video interface. If the temperature in the scene is higher than 30.2°C, the equipment will give an audible alarm. Click the alarm icon to immediately turn off the high temperature alarm sound.

Turn on the **low temperature alarm** switch to set the alarm temperature threshold (e.g. 30.2°C) as required. Return to the real-time video interface. If the temperature in the scene is lower than 30.2°C, the equipment will give an audible alarm. Click the alarm icon to immediately turn off the low-temperature alarm sound.

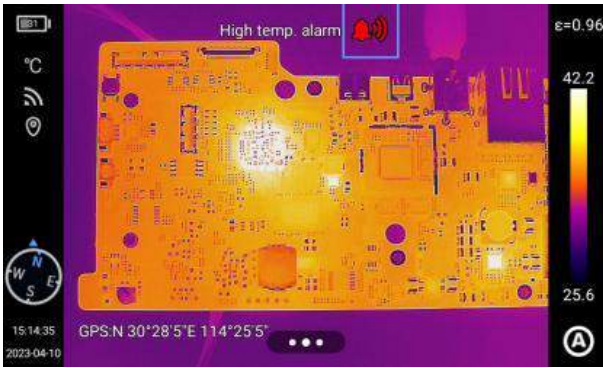

When the high-temperature alarm and low-temperature alarm switches are turned on at the same time, in order to ensure that the system is able to detect the set high-temperature alarm value, the low-temperature alarm value should not be higher than the high-temperature alarm setting.

The alarm modes include sound alarm and light alarm.

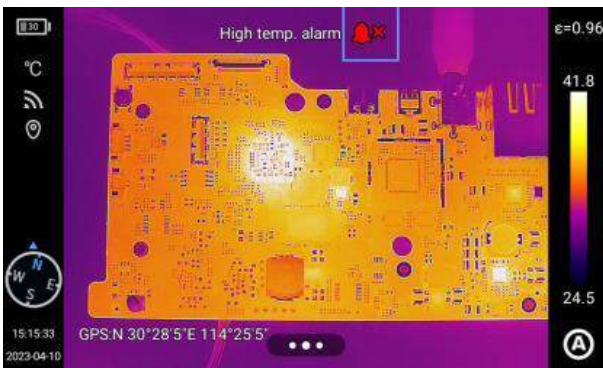

Click the alarm icon in the real-time preview interface to turn off temperature alarm.

8.4 Image marks

Click **Image Tags** to display the temperature, unit, location, date, time, compass, logo, color and center cursor; users can enable the tags as demanded, which will be displayed on the real-time image.

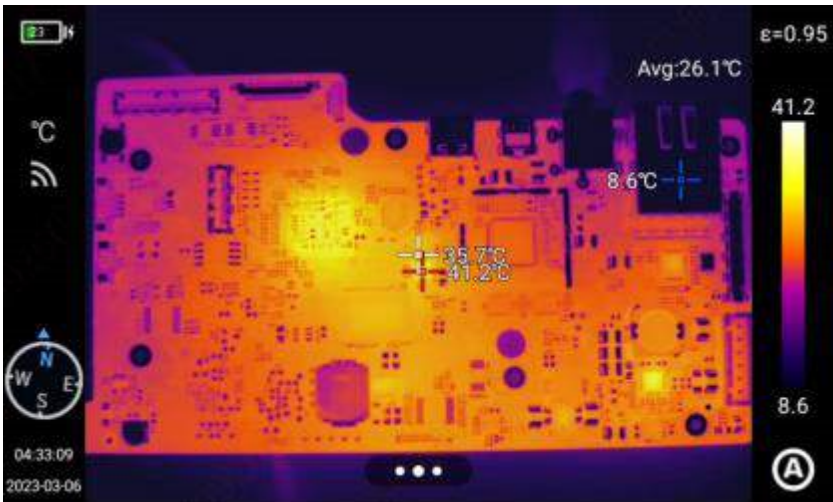
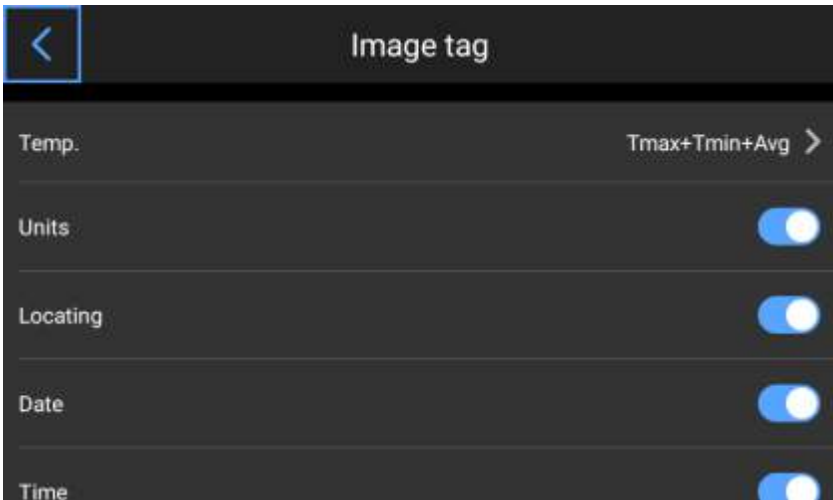

8.5 Image watermark

Here you can enable some watermark options, including logo watermark, date watermark, humidity watermark, orientation, emissivity, emission temperature and target distance watermark.

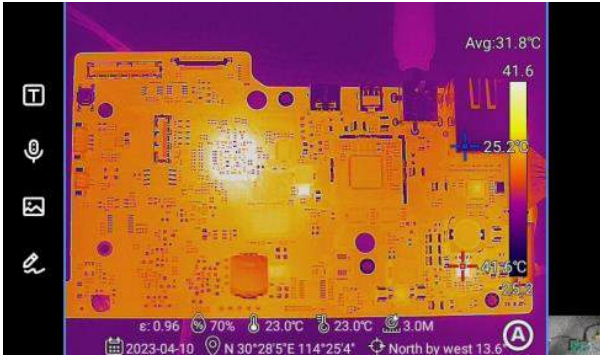

Take an example image and display it in the **Gallery**. All the watermark information that has been turned on will be displayed at the bottom of the preview.

8.6 Key assist

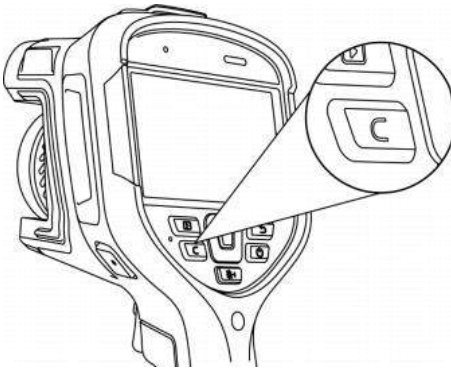

Sets the **C** button for quick operation.



8.7 Ledger management

The device supports adding locally, importing local templates and downloading from the cloud. Click "Tasks" in the drop-down menu to go to the "Ledger" interface. Click "+" at the upper right corner to create new ledgers and go to a single ledger.

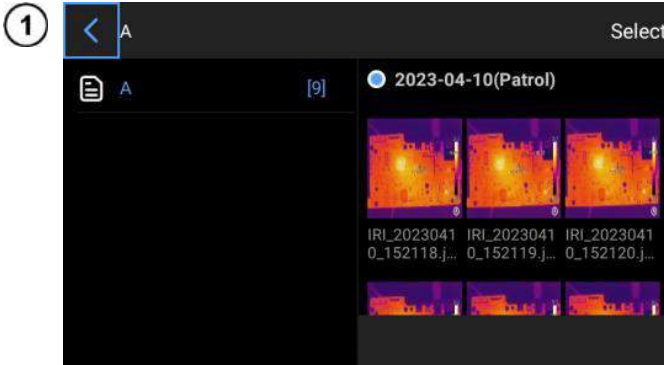

Click **Task Photo** to display the photos taken at this measuring point under all task modes in the current ledger.

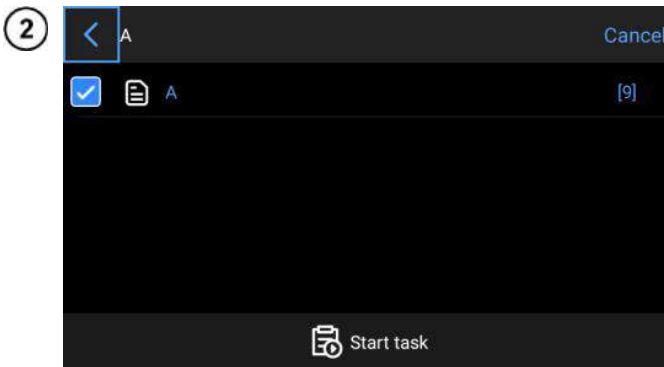

Click **Select Tasks** and select the points to go to the main preview interface to take photos.

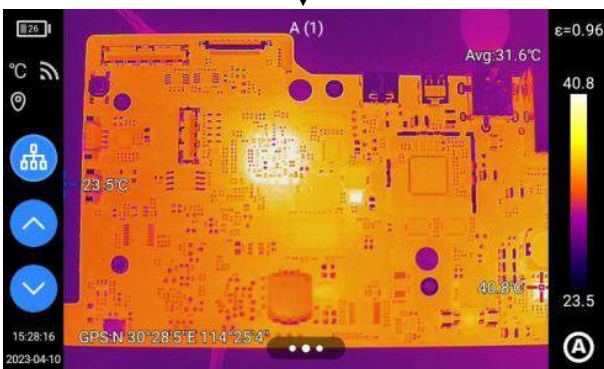

3

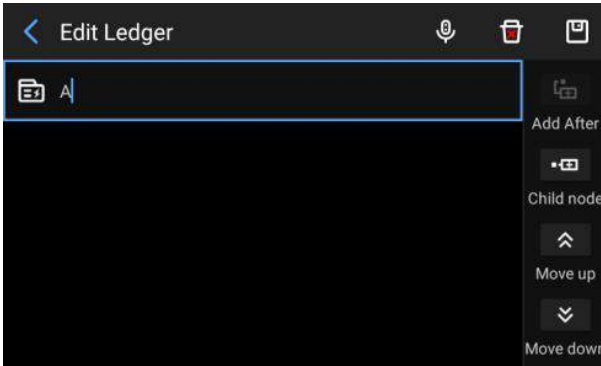

Click **Change the ledger** to add points, move up, move down, save and delete the ledger.

8.8 Task management

The device supports adding ledgers locally and downloading from the cloud. Click "Tasks" in the drop-down menu to go to the **My Tasks** interface. Click "+" at the upper right corner to create a new task list and go to a single task.

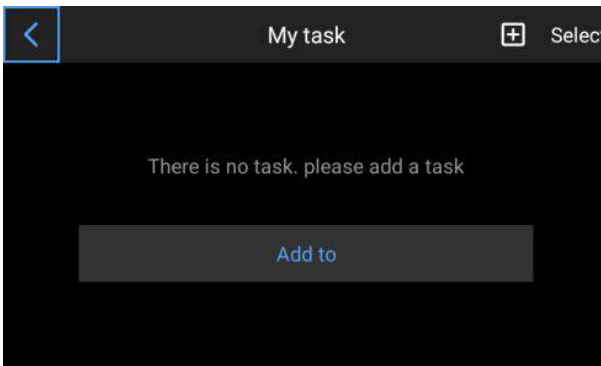

1

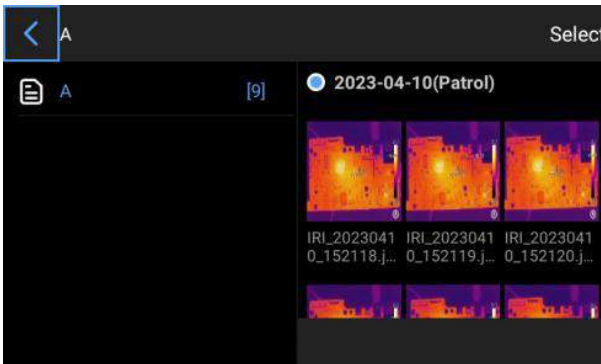

Click  to view the task details, which can be edited and saved.

2

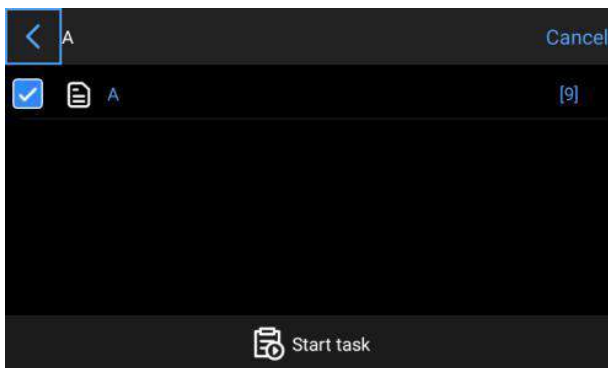

- Select a point and click **Start Tasks** and go to the main preview interface to take photos.
- Click **Task Photo** to go to the photo details page to view the photo information of the selected point.
- Click **Change Tasks** go to details of the ledger selected when creating the task and reselect a task.
- Click **Delete Tasks** and a window pops up for re-confirmation, and the task is deleted successfully.

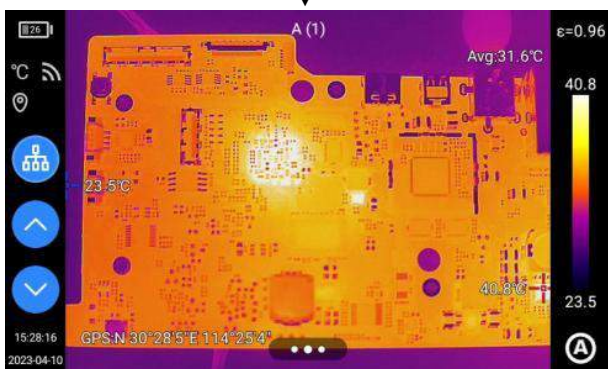

8.9 AI voice

Enable AI voice with the **Key assist** function. "Identifying..." is displayed when there is a voice command. Operation stops when an AI order is identified.

The designated names include: Photo, Video, Focus, Calibrate, Change Ribbon, IR, VL, PIP, MIF, Fusion, Light On, Light Off, Start Task and End Task.

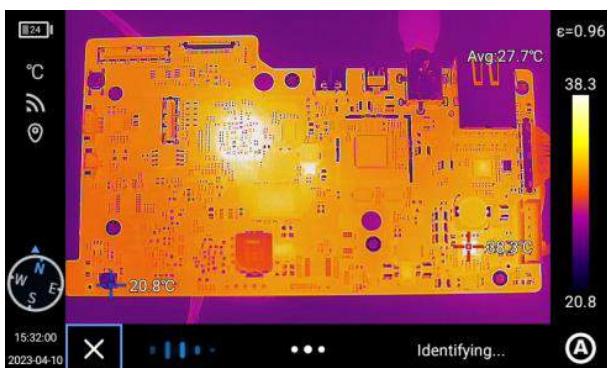

8.10 Unit switch

You may switch the temperature units of Celsius, Fahrenheit and Kelvin displayed by the system as required.

There are three distance units to choose from: meters, yards and inches.

8.11 Save parameters

Device parameter settings: Visible light resolution, infrared video format, infrared video frame rate, save this JPG photo only and laser ranging.

8.12 Laser ranging

Enable the laser ranging function and go back to the live mode. The distance information will be saved on the picture taken using the  button.

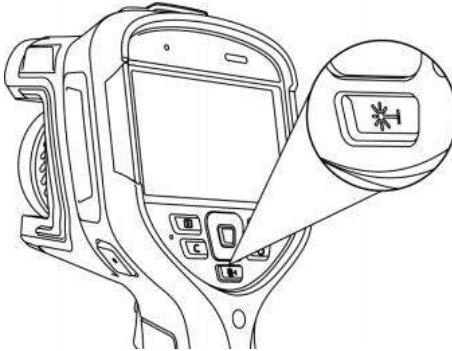

8.13 Report parameters

Several PDF report parameters can be modified, including logo, header, footer and PDF template.

8.14 Preference settings

Users may add global preferences according to their own operating habits, and can also change and delete preferences.

8.15 Password lock

Users may utilize the password protection function in device startup according to their own operating habits.

8.16 Shutdown and sleep

- Set the automatic sleep option.
- Set the option of automatic shutdown.

8.17 Wi-Fi

- Select a network. Click on one of the listed networks and (if necessary) enter the password.
- Connect the network after the password is successfully inputted.



In order to ensure the reliable connection of Wi-Fi signals and stable data transmission, please try to ensure that the connection distance is within 10 m and there are no obstacles.

8.18 Network connections

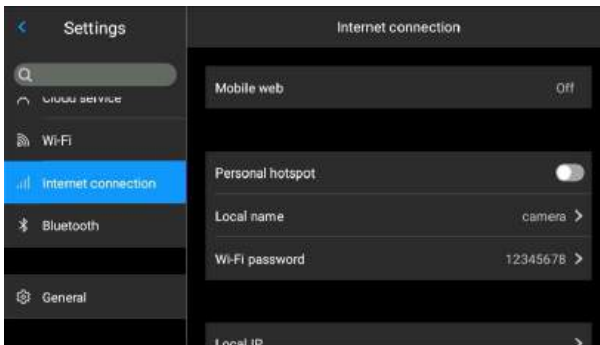

Mobile network:

This device supports external 4G mobile networks.

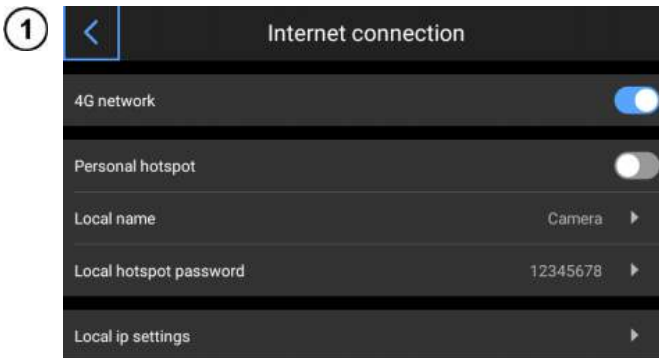

Wi-Fi hotspot:

- In the configuration interface, enter a valid hotspot name (i.e. Camera) and password (i.e. 12345678), and click OK to save.
- Then return to live mode and pull up to pop up the shortcut menu. Enable AP function.

2

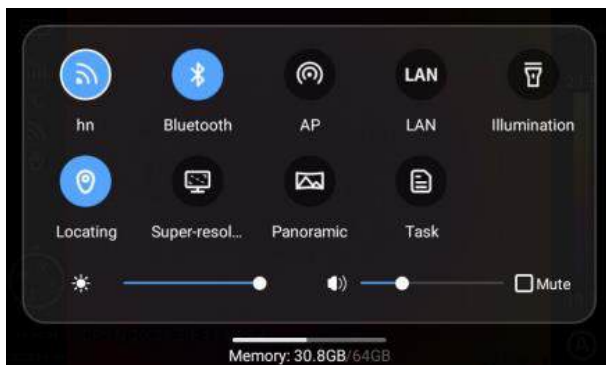

- After the AP is successfully enabled, the user may enter the correct user name and password using in his Bluetooth app. Then the device network can be connected successfully and images from live mode can be displayed.

Local IP:

Users may set the IP address and DNS server address by themselves.



- **IP address.** Enter a valid IP address (such as 172.16.14.216) and DNS server address 202.103.24.68. Please set the IP address and DNS address by yourself according to the local area network situation of the user.
- (Note: IP address cannot be set for the 192.168.42.xxx network segment, which will be prompted as “illegal IP address”).
- **Host IP.** Set the local connection IP address of desktop computer as 172.16.14.230, and DNS as 202.103.24.68. Then it can be used together with supporting software*.

*It needs to be used together with PC-side application software

8.19 Bluetooth



- Enable the Bluetooth of the target device.
- Enable Bluetooth and the system will automatically search for the Bluetooth devices. Select a Bluetooth name in the list to pair.
- Photos can be transferred after pairing is completed (the device supports to transfer the photos from the device gallery to an Android phone or another device).



If the two devices are far apart or Bluetooth pairing is not performed in the gallery interface, Bluetooth may not be found. At this time, enable the Bluetooth again.

8.20 General

Users may check the version and serial number of native software through **Settings ► General**, and may change information such as language, time, date and storage path.

8.20.1 Check for update

Check the device version update.

Local updating

Put the update package under **/GCamera/Update** and click **Start Update**. After detecting the latest update package, click **Update** and after the updating is completed, restart the device that is updated to the latest version.

8.20.2 Storage

The main display contents are the remaining capacity of the internal storage device and the basic information of the external SD card. Users may also customize the storage options, including internal storage and external SD card storage.

Select storage medium: enter the device storage interface, and the user may select memory storage device or SD card for data storage.

8.20.3 Date and time

Manually set the system date and time.

8.20.4 Language

Multiple languages are available for switching

8.20.5 Synchronous data

If the SD card is changed to another device and the gallery does not display the files in the SD card, data synchronization is required.

8.20.6 Format SD card

To start formatting, you have to select a memory card slot, and then select Yes. Please note that formatting will permanently delete all photos and other data on the memory card in the selected slot. Be sure to back up as needed before formatting.

8.20.7 Recovery

This function will restore the device to the factory state. Please handle it carefully. Go to **Settings** ► **General**, and click **Restore factory settings**.

8.20.8 Lens recognition

Automatically recognizes the current lens based on the information of the lens for the device.

9 Port connection

9.1 USB port

View internal storage files

After connecting the USB data cable to the desktop computer, open **My Computer**, check the information of the internal storage disk, click to enter the memory device, and find the folder where the images are stored. The specific path is:

...\CAMERA\ internal storage device \DCIM\GCamera\SourceImage.

View the SD card files

If you want to save the images in SD card, please navigate to **Settings ► General ► Storage Management**, select SD card as the storage medium, and then files can be saved in the memory card after photographing.

Connect to the computer with the USB data cable, open **My Computer**, view the information of the internal storage disk, and click to enter the memory device. The path is:

...\CAMERA\SD card \DCIM\ Android\data\com.guide.infrared.zc16\DCIM\GCamera\SourceImage



The file name with the initial letters of IRI is the infrared image, and the file name with the initial letters of VIS is the visible image.

10 SD card

SD card can be used in this device, and the shot images and videos can be recorded on this device or SD card. This device supports SD cards with a maximum capacity of 256 GB. Make sure that the write protection switch of the memory card is set in the upper position to allow writing/deleting.

10.1 Installing SD card in the camera



NOTE!

Turn off the camera before installing SD card.

①



- Slide the slot cover in the arrow direction shown in the figure and open it, and insert the SD card.
- Insert the SD card with the label side facing towards you until there is a click.

②



Close the slot cover and slide it in the arrow direction shown until it is locked.

10.2 Removing SD card



NOTE!

Turn off the camera before removing SD card.

- Power off the device and open the slot cover (open the slot cover after the indicator lights off).
- Take out the SD card. Gently push the SD card and release.
- Pull out the SD card and close the slot cover.

11 Replacing the lens



NOTE!

It is advised to turn off the camera before replacing the lens.

1

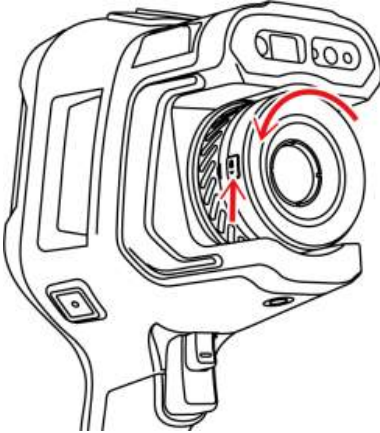

Press the lens changing button and rotate the lens anticlockwise and take it off.

2

Align the U-shape groove of the lens at the red point on the device and insert the lens, and rotate the lens anticlockwise until a "click" is heard.



NOTE!

- Handle with care to avoid direct collision and lens damage;
- When not in use, please place the extended lens in a safety box and keep it properly.
- Do not touch or expose the internal parts of the camera to prevent them from fouling.

12 Power supply and battery charging

- The camera is powered by Lithium-ion battery. It can also be powered from the mains through the AC adapter.
- The battery can be charged while being inside of the camera.
- Connect the AC adapter to the USB socket to start charging procedure.
- Charging can be performed only when the camera is not being used.
- During camera operation, current power supply source indicator is displayed in the upper left corner of the screen.

12.1 Using AC adapter

The LED light [20] indicates when the AC adapter is connected. When the camera is turned on, the indicator shows battery charging status, flashing red while charging and lit green when fully charged.

12.2 Battery power supply

During camera operation the battery charge level is being shown in real time.

12.3 Charging batteries

When the camera is turned off, connecting the AC adapter and starting the charging procedure is signaled by the LED charging indicator [20] – flashing red while charging and lit green when fully charged. When the battery is not being charged the indication is turned off.

Li-Ion battery does not require performing full charge-discharge cycles during exploitation, however **it is advised to perform 3 full charge-discharge cycles when using it for the first time**, and to perform one full charge cycle at least once in a several charge-discharge cycles.

The camera comes along with 2 batteries, which are advised to be used alternately. When using the second battery, the first one should be charged.



NOTE!

- Use only the battery, AC adapter and the external battery charger supplied with the camera.
- Do not remove the battery from the camera while it's being charged.
- Battery charging should be performed in 0...40°C ambient temperature range.
- In order to maintain the proper parameters of the batteries, charging of unused batteries should be repeated every 3 months.

12.4 Charging the battery in the external battery charger



NOTE!

Turn the camera off before removing the battery.

The battery is located in the handle of the camera. Both its removal and installation does not require tools.



To remove the battery:

- turn off the camera,
- evenly squeeze the battery handle on both sides and pull it out of the camera.

In order to install the battery, repeat the above process in reverse order.

12.5 General rules of using Lithium (Li-Ion) batteries

If the device is unused for an extended period, remove the battery and store it separately. The battery stored in state of deep discharge can get permanently damaged.

The battery should be stored in dry, cool and well-ventilated place and it should be protected from exposure to direct sunlight. If the battery is stored for an extended period at a location with high temperature in it, then the chemical processes occurring within it may shorten its expected life span.

Do not charge and use Li-On batteries in extreme temperatures (don't overheat and don't expose the batteries to very low temperatures). Extreme temperatures decrease battery life. Avoid placing devices powered with rechargeable batteries in very warm/hot places. Their nominal working temperature must be strictly observed.

Li-Ion cells are vulnerable to mechanical damages. Such damages can contribute to permanent damage of those type of batteries, and thus the ignition. Any interference in the structure of the battery may lead to its damage. Shorting poles (+ and -) of the battery may cause permanent damage and auto-ignition of the battery.

Do not immerse the Li-Ion batteries in liquids, do not store them in conditions of high humidity.

In case the electrolyte, that is filling the inside of the Li-Ion battery, makes direct contact with eyes or skin, rinse them with a large amount of water and contact your doctor immediately. The battery should be used in a way that makes it beyond access for random people. Keep it away from children.

Whenever any changes in Li-Ion battery is observed (different color, swelling, excessive temperature), it must cease to be used. Mechanically damaged, overcharged or deeply discharged batteries are not suitable for use.

Improper use of the battery can cause its permanent damage. It can lead to its spontaneous combustion. The seller and the manufacturer shall not be liable for any damages resulting from improper handling of the Lithium-Ion battery.

13 Troubleshooting

| Phenomena | Cause | Measures |
|--|---|--|
| Unable to start. | Low battery. | Recharge the battery before use. |
| | Poor battery contact. | Take out the battery and put it back in place in the battery housing. |
| | Plug of the external power supply not in place. | Remove the power plug and reinsert it in place. |
| Great deviation between the battery power indication and the actual use. | Battery runs out. | Replace it with a fully charged battery. |
| | Expiration of battery life. | Replace with a new battery. |
| Unclear infrared images. | Failure in focusing. | Focus manually or automatically to make images clear. |
| | Lens fogged or contaminated. | Use professional equipment to clean the lens. |
| Unclear visible light images. | Dark environment. | Take appropriate lighting measures. |
| | Front end of visible light fogged or contaminated. | Use professional equipment to clean the front end of visible light. |
| Inaccurate temperature measurement. | Failure in focusing on the target. | Focus manually or automatically to make the image clear, and then read the temperature. |
| | Wrong parameters related to temperature measurement. | Change the parameter setting, or directly restore the default parameter value. |
| | Failure in non-uniformity correction for a long time. | Set the Customize button as compensation in the menu, press the physical Customize button and perform a non-uniformity correction when you hear the shutter sound. |
| | Temperature measurement immediately after start. | To ensure the accuracy of temperature measurement, you are recommended to wait for 5 to 10 minutes after turning on the thermal imager and before temperature measurement. |
| | Failure in calibration for a long time. | To obtain accurate temperature measurement results, you are recommended to send the thermal imager back for calibration once a year. |
| Fail to save files | The remaining storage space is insufficient. | Delete the photos and videos in the gallery. |
| | The SD card is damaged. | Pull out the SD card and insert on the computer for formatting or replace with a new SD card. |

14 Specifications

| Model | KT-510 | KT-520 | KT-525 | KT-530 | KT-550 |
|---|---|---|--|--|--|
| Camera | | | | | |
| Detector resolution | 256 x 192 / 12 µm | 320 x 240 / 12 µm | 384 x 288 / 12 µm | 480 x 360 / 12 µm | 640 x 480 / 12 µm |
| Spectral range | 7.5-14 µm VOx | | | | |
| Frame rate | 30 Hz / 9 Hz | | | | |
| Thermal sensitivity | ≤45 mK | | | | ≤40 mK |
| Focus | Manual / Auto | | | | |
| IFOV | 1.70 mrad | 1.36 mrad | 1.13 mrad | 0.91 mrad | 0.68 mrad |
| Min. focus distance | 0.1 m | 0.1 m | 0.15 m | 0.15 m | 0.15 m |
| Lens (field of view/focal length) | 25° x 19° / 10.5 mm | 25° x 19° / 10.5 mm | 25° x 19° / 10.5 mm | 25° x 19° / 17.7 mm | 25° x 19° / 17.7 mm |
| Image | | | | | |
| Display | 4.3", 800 x 480 high brightness, LCD touchscreen | | | | |
| Image modes | IR / Visual / Infrarufusion MIF/PIF | | | | |
| Digital Zoom | 1...8 | 1...8 | 1...10 | 1...16 | 1...20 |
| Temperature measurement | | | | | |
| Temperature range | Range 1: -40°C...150°C Range 2: 0°C...650°C | | | | |
| • Standard | High temperature lens: 500°C ...2000°C | | | | |
| • Optional | - | | | | |
| Accuracy (Ambient: 15°C ...35°C, object: >0°C) | ±2°C or ±2% of reading | | | | |
| Functions | | | | | |
| Image analysis modes | 5 points, 5 lines, 5 areas. Temperature indication: min, max, average. Isotherm. Temperature alarm. Smart stroke. | 8 points, 8 lines, 8 areas. Temperature indication: min, max, average. Isotherm. Temperature alarm. Smart stroke. | 10 points, 10 lines, 10 areas. Temperature indication: min, max, average. Isotherm. Temperature alarm. Smart stroke. | 12 points, 12 lines, 12 areas. Temperature indication: min, max, average. Isotherm. Temperature alarm. Smart stroke. | 16 points, 16 lines, 16 areas. Temperature indication: min, max, average. Isotherm. Temperature alarm. Smart stroke. |
| Palettes | 16 | | | | |
| Super-resolution | 2x, 512 x 384 | 2x, 640 x 480 | 2x, 768 x 576 | 2x, 960 x 720 | 2x, 1280 x 960 |
| Panoramic images | √ | | | | |
| Emissivity coefficient | Selectable from 0.01 to 1.00 | | | | |
| Measurement adjustment | Auto-adjustable distance, relative humidity, ambient temperature (reflected) | | | | |
| File format | JPG | | | | |
| IR image annotations | Additional visual photos, voice, text recognition, text typing | | | | |
| Reports module | PDF reports | | | | |
| Video file format | MP4 (without temp. information), IRGD (including temp. information) | | | | |
| Built-in features | | | | | |
| • Visual camera resolution | 5 MPix | 5 MPix | 8 MPix | 8 MPix | 13 MPix |
| • Other features | LED flashlight, GPS, laser pointer, laser rangefinder (0.1...40 m), microphone, speaker, digital compass | | | | |
| Wireless communication | Wi-Fi, Bluetooth | | | | |
| Storage | Built-in memory (64 GB), SD card | | | | |
| Interface | SD card slot (max. 256 GB), USB type C, tripod | | | | |
| Power supply | Li-ion battery (5 h of continuous operation), built-in charger, AC adapter 110-230 V (50/60 Hz) | | | Li-ion battery (4 h of continuous operation), built-in charger, AC adapter 110-230 V (50/60 Hz) | |
| Environmental conditions | | | | | |
| Operating / Storage temp | -20°C...50°C / -40°C...60°C | | | | |
| Humidity | ≥95% | | | | |
| Resistance to vibration / mechanical shock / humidity and temperature | IEC 60068-2-6 / IEC 60068-2-27 / IEC 60068-2-78 | | | | |
| Ingress protection | IP54 | | | | |
| Certification | CE, ROHS, FCC, KCC, UN38.3, MSDS | | | | |
| Weight | approx. 1.15 kg (with battery) | | | | |
| Dimensions | 292 x 125 x 125 mm | | | | |



SONEL S.A. hereby declares that the radio device type KT-510/520/525/530/550 complies with Directive 2014/53/EU. The full text of the EU Declaration of Conformity is available at the following website address: <https://sonel.pl/en/download/declaration-of-conformity/>

15 Cleaning and maintenance



NOTE!

Use the below specified methods of maintenance only.

Camera enclosure – all surfaces, except for optical elements of the camera, can be cleaned with a soft and moist cloth with generally available mild detergents. Do not use any solvents or cleaning agents that could scratch the enclosure (powder, paste, etc.). During cleaning, the camera must be turned off.

Due to the applied anti-reflective coating, optical lens are the most sensitive and at the same time the most expensive part of the camera (the lens is of key importance to radio-metric capabilities of the infrared system). Therefore it is important to close the protective lens cover after each use of the camera. Optical surfaces should be cleaned only, when they are visibly fouled. Do not touch exposed surfaces of optical lens with fingers, because fouling left with fingerprints can be harmful to coatings and glass of the lens.

Chemical agents must not be used for cleaning the optical viewfinder, and particularly optics and accessories of the camera. Use a clean, dry and soft cloth for cleaning the body of the viewfinder; for cleaning the lens, use only the supplied lens cleaning cloth.

16 Service and storage

Thermal imaging cameras don't comprise any parts serviceable by the user. Do not attempt to dismantle or modify the camera on your own. Opening the instrument voids the warranty.



NOTE!

Only the manufacturer is authorized to perform service repairs.

When storing the instrument, observe the following guidelines:

- make sure the camera and its accessories are dry,
- when storing the camera for a prolonged time, remove the batteries,
- allowed are storage temperatures specified in technical specifications,
- in order to avoid complete discharging of rechargeable batteries during prolonged storage, charge them once in a while.

17 Dismantling and disposal

- Used-up electrical or electronic equipment must be collected selectively, i.e. must not be mixed with waste of other types.
- Used-up electronic equipment must be delivered to an appropriate collection centre in accordance with regulations related to used-up electrical or electronic equipment.
- Before delivering the equipment to the collection centre do not attempt to dismantle any of its parts.
- Follow local regulations related to disposing of packaging, used-up batteries and rechargeable batteries.

18 Optional accessories

The full list of accessories can be found on the manufacturer's website.

| Name | KT-510 | KT-520 | KT-525 | KT-530 | KT-550 |
|---|--------|--------|--------|--------|--------|
| • Wide-angle IR lens (44°x34°/6 mm/1.99 mrad/0.1 m) – WAADAO6V5XX | √ | √ | √ | | |
| • Wide-angle IR lens (44°x34°/10 mm/1.2 mrad/0.1 m) – WAADAO10V5XX | | | | √ | √ |
| • Tele IR lens (15°x11°/17.5 mm/0.68 mrad/1 m) – WAADAO18V5XX | √ | √ | √ | | |
| • Tele IR lens (15°x11°/29 mm/0.41 mrad/1 m) – WAADAO29V5XX | | | | √ | √ |
| • Ultra-tele IR lens (7°x5°/37.5 mm/0.32 mrad/3 m) – WAADAO375V5XX | √ | √ | √ | | |
| • Ultra-tele IR lens (7°x5°/62.9 mm/0.19 mrad/3 m) – WAADAO63V5XX | | | | √ | √ |
| • Macro IR lens (3x/16.2 mm/100 mm) – WAADAO16V5XX | | | | √ | √ |
| • High temperature filter 2000°C (25°x19°) – WAADAOF3 | | √ | √ | √ | √ |

19 Manufacturer

The manufacturer and provider of warranty and post-warranty services for this instrument is:

SONEL S.A.

Wokulskiego 11
58-100 Świdnica
Poland

tel. +48 74 884 10 53 (Customer Service)

e-mail: customerservice@sonel.com

web page: www.sonel.com

20 Exemplary emissivity coefficient values

| | | | |
|--------------------------------|--------------|-------------------------------|------|
| aluminum..... | 0.05 | lead: polished | 0.08 |
| aluminum rough..... | 0.07 | lead: grey..... | 0.28 |
| aluminum oxidized..... | 0.25 | lead: oxidized..... | 0.63 |
| asphalt..... | 0.90 | paper white..... | 0.90 |
| asbestos board | 0.96 | paper black glossy..... | 0.90 |
| asbestos (fiber)..... | 0.78 | paper black dull | 0.94 |
| akelite..... | 0.93 | paper: tarred..... | 0.92 |
| bronze: dull | 0.22 | plastic: black..... | 0.95 |
| bronze: polished | 0.10 | platinum..... | 0.10 |
| bronze: rough | 0.55 | porcelain: glazed..... | 0.92 |
| brick: glass.. rough..... | 0.85 | mercury | 0.10 |
| brick: fireproof. rough..... | 0.94 | lampblack | 0.96 |
| cement..... | 0.54 | silver..... | 0.03 |
| cement (concrete)..... | 0.90 | steel: galvanized..... | 0.28 |
| chrome | 0.15 | steel: oxidized..... | 0.88 |
| chrome polished | 0.10 | steel: rolled freshly..... | 0.24 |
| tin | 0.09 | steel: rolled..... | 0.56 |
| zinc..... | 0.05 | steel: rough..... | 0.96 |
| brick red..... | 0.93 | steel: rusty red..... | 0.69 |
| paint: oil..... | 0.94 | steel nicked..... | 0.11 |
| clay: fired..... | 0.91 | glaze..... | 0.90 |
| clay..... | 0.40 | glass..... | 0.92 |
| graphite | 0.85 | glass dull | 0.96 |
| ground: frozen | 0.93 | snow..... | 0.80 |
| rubber..... | 0.93 | tape insulation | 0.95 |
| cobalt..... | 0.18 | fabric | 0.85 |
| quartz | 0.93 | titanium..... | 0.30 |
| lacquer white | 0.87 | carbon | 0.90 |
| lacquer polished black | 0.87 | charcoal powder | 0.96 |
| lacquer dull black..... | 0.97 | tungsten..... | 0.13 |
| lacquer silver | 0.31 | tungsten: oxidized..... | 0.11 |
| ice..... | 0.97 | gold | 0.02 |
| magnesium..... | 0.12 | iron: glossy | 0.16 |
| copper: oxidized..... | 0.65 | iron: heat rolled..... | 0.77 |
| copper: oxidized black | 0.88 | iron: oxidized | 0.74 |
| copper: polished | 0.07 | iron: polished..... | 0.23 |
| copper: polished annealed..... | 0.01 .. 0.02 | iron and steel: oxidized..... | 0.85 |
| brass..... | 0.10 | cast: raw casting..... | 0.81 |
| brass: oxidized..... | 0.61 | cast: polished..... | 0.21 |
| nickel: polished..... | 0.05 | | |

NOTATKI

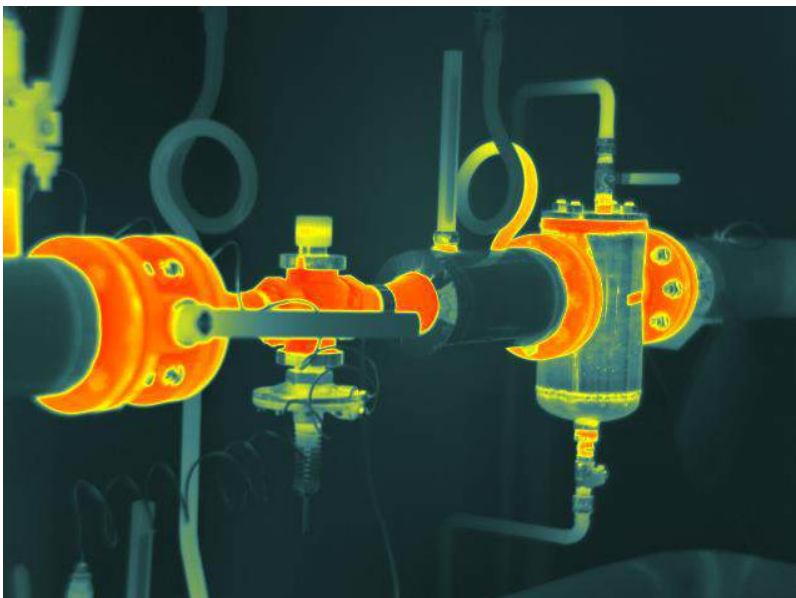

SONEL S.A.

Wokulskiego 11
58-100 Świdnica
Poland

Customer Service

tel. +48 74 884 10 53
e-mail: customerservice@sonel.com

www.sonel.com