

USER MANUAL

INSULATION RESISTANCE METER

MIC-10k1 • MIC-5050

MIC-10k1 • MIC-5050

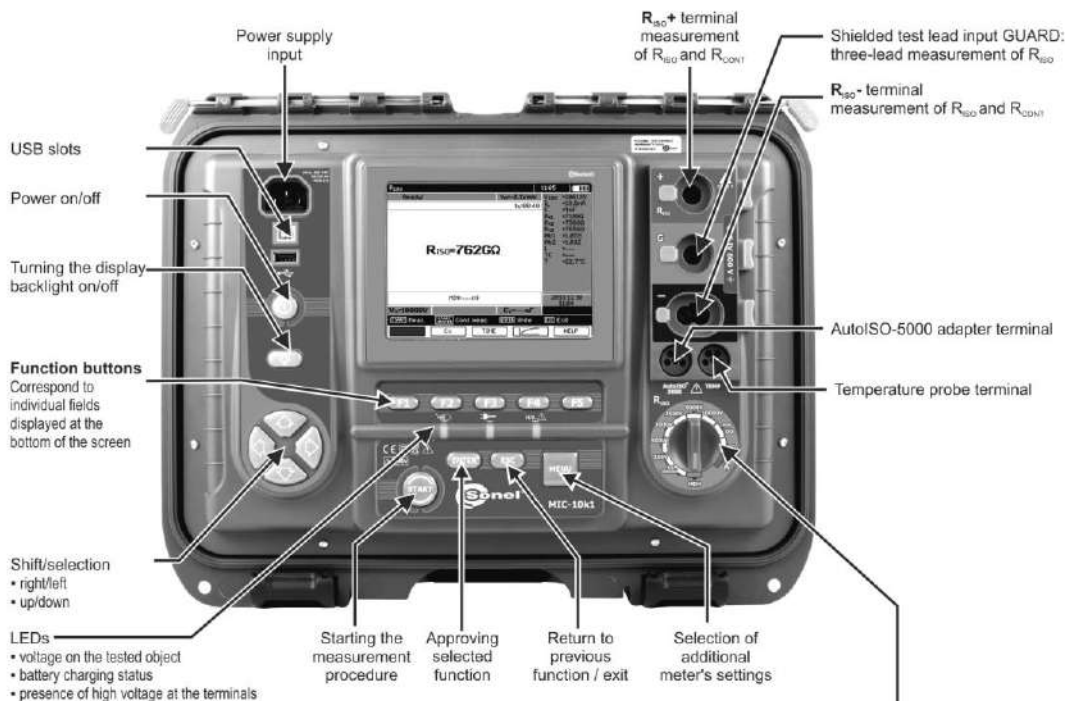

USB slots

Power on/off

Turning the display backlight on/off

Function buttons

Correspond to individual fields displayed at the bottom of the screen

Shift/selection
• right/left
• up/down

LEDs
• voltage on the tested object
• battery charging status
• presence of high voltage at the terminals

R_{res}+ terminal
terminal measurement of R_{ISO} and R_{CONT}

Shielded test lead input **GUARD**:
three-lead measurement of R_{ISO}

R_{iso}- terminal
terminal measurement of R_{ISO} and R_{CONT}

AutoISO-5000 adapter terminal

Temperature probe terminal

Starting the measurement procedure

Approving selected function

Return to previous function / exit

Selection of additional meter's settings

Rotary switch of function selection

MIC-5050

- **MEM** - viewing memory data
- **50...5000V** - R_{ISO} measurement with test voltage adjusted within the range of 50 V...5 kV
- **250V** - R_{ISO} measurement using test voltage of 250 V
- **500V** - R_{ISO} measurement using test voltage of 500 V
- **1000V** - R_{ISO} measurement using test voltage of 1000 V
- **2500V** - R_{ISO} measurement using test voltage of 2500 V
- **5000V** - R_{ISO} measurement using test voltage of 5000 V
- **DD** - dielectric discharge indicator
- **SV** - measurement with increasing voltage
- **🔥** - Damage location (after-burning)
- **R_{cont}** - measurement of circuit continuity (specific meters)

MIC-10k1

- **MEM** - viewing memory data
- **50...10000V** - R_{ISO} measurement with test voltage adjusted within the range of 50 V...10 kV
- **250V** - R_{ISO} measurement using test voltage of 250 V
- **500V** - R_{ISO} measurement using test voltage of 500 V
- **1000V** - R_{ISO} measurement using test voltage of 1000 V
- **2500V** - R_{ISO} measurement using test voltage of 2500 V
- **5000V** - R_{ISO} measurement using test voltage of 5000 V
- **10000V** - R_{ISO} measurement using test voltage of 10 kV
- **DD** - dielectric discharge indicator
- **SV** - measurement with increasing voltage
- **🔥** - Damage location (after-burning)
- **R_{cont}** - measurement of circuit continuity (specific meters)



USER MANUAL

INSULATION RESISTANCE METER MIC-10k1 • MIC-5050



**SONEL S.A.
Wokulskiego 11
58-100 Świdnica
Poland**

Version 2.09 01.10.2024

MIC-10k1 and MIC-5050 meters are modern, high-quality meters, easy and safe in operation. Please acquaint yourself with this manual in order to avoid measuring errors and prevent possible problems in operation of the meter.

CONTENTS

1 Safety	5
2 Menu	6
2.1 Wireless transmission	6
2.2 Measurement settings	7
2.2.1 Mains frequency	7
2.2.2 Times t1, t2, t3 for calculating absorption coefficients	8
2.2.3 Type of absorption coefficients	8
2.2.4 I _{ISO} short-circuit current	9
2.2.5 Setting limit values	9
2.2.6 Temperature unit	10
2.2.7 Auto-incrementing of the memory cell number	10
2.2.8 Filter	11
2.2.9 Chart type selection	11
2.3 Meter settings	12
2.3.1 LCD contrast	12
2.3.2 Automatic shut-off (Auto-OFF)	13
2.3.3 Date and time	13
2.3.4 Factory (default) settings	14
2.3.5 Software update	14
2.3.6 Key sounds	15
2.3.7 Wireless communication	16
2.4 Language selection	16
2.5 Information about manufacturer	16
3 Measurements	17
3.1 Diagnostics performed by the meter – limits	17
3.2 Measurement of insulation resistance	17
3.2.1 Double-lead measurement	18
3.2.2 Three-lead measurement	24
3.2.3 Measurements with AutoISO-5000	26
3.2.4 Measurements with increasing voltage – SV	30
3.2.5 Dielectric Discharge Indicator – DD	31
3.2.6 Damage location (after-burning)	34
3.3 Low-voltage measurement of resistance	35
3.3.1 Measurement of resistance of protective conductors and equipotential bonding with ±200 mA current	36
3.3.2 Calibration of test leads	37
3.4 Correcting the R _{ISO} value to the reference temperature	38
3.5 Determining the length of the tested cable	39
3.6 Tightness test of MV cable jacket	40
4 Memory of measurement results	41
4.1 Structure of the Memory	41
4.1.1 The appearance of main windows in the measurement recording mode	41
4.2 Storing the measurement results in the memory	43
4.2.1 Entering the results without extending the memory structure	43
4.2.2 Extending the memory structure	44
4.3 Viewing memory data	49
4.4 Deleting memory data	51

5	Data transmission	52
5.1	Set of accessories to connect the meter to a PC	52
5.2	Data transmission through USB port	52
5.3	Data transmission using Bluetooth module	53
5.4	Read-out and change of PIN code for Bluetooth connections	53
6	Power supply of the meter	55
6.1	Monitoring the power supply voltage	55
6.2	Battery power	55
6.3	Charging rechargeable battery	56
6.4	Power supply from mains	56
6.5	General principles for using Li-Ion rechargeable batteries	57
6.6	General principles for using gel (lead) rechargeable batteries	57
7	Cleaning and maintenance	58
8	Storage	58
9	Dismantling and utilisation	58
10	Technical specifications	59
10.1	Basic data	59
10.2	Other technical data	62
10.3	Additional data	63
10.3.1	Additional uncertainties according to EN 61557-2 (R_{ISO})	63
10.3.2	Additional uncertainties according to EN 61557-4 (R_{CONT})	63
11	Manufacturer	63

1 Safety

MIC-10k1 and MIC-5050 meters are designed for performing check tests of protection against electric shock in mains systems. The meters are used for making measurements and providing results to determine safety of electrical installations. Therefore, in order to provide conditions for correct operation and accuracy of obtained results, the following recommendations must be observed:

- Before you proceed to operate the meter, acquaint yourself thoroughly with the present manual and observe the safety regulations and specifications provided by the producer.
- Any application that differs from those specified in the present manual may result in a damage to the device and constitute a source of danger for the user.
- MIC-10k1 and MIC-5050 meters must be operated only by appropriately qualified personnel with relevant certificates authorising the personnel to perform works on electric systems. Operating the meter by unauthorised personnel may result in damage to the device and constitute a source of danger for the user.
- During measurements of insulation resistance, dangerous voltage up to 10 kV (MIC-10k1) or 5 kV (MIC-5050) occurs at the ends of test leads of the meter.
- Before the measurement of insulation resistance you must be sure that tested object is disconnected from the power supply.
- During the measurement of insulation resistance do not disconnect test leads from the tested object before the measurement is completed (see par. 3.2.1); otherwise the capacitance of the object will not be discharged, creating the risk of electric shock.
- Using this manual does not exclude the need to comply with occupational health and safety regulations and with other relevant fire regulations required during the performance of a particular type of work. Before starting the work with the device in special environments, e.g. potentially fire-risk/explosive environment, it is necessary to consult it with the person responsible for health and safety.
- It is unacceptable to operate:
 - ⇒ a damaged meter which is completely or partially out of order,
 - ⇒ a meter with damaged insulation,
 - ⇒ a meter stored for an excessive period of time in disadvantageous conditions (e.g. excessive humidity). If the meter has been transferred from a cool to a warm environment with a high level of relative humidity, do not start measurements until the meter is warmed up to the ambient temperature (approximately 30 minutes).
- Remember that **BAT!** message appearing on the display indicates insufficient voltage of power supply and the need to recharge the batteries.
- Before measurement, choose a correct measurement function and make sure that test leads are connected to respective measuring terminals.
- Do not power the meter from sources other than those listed in this manual.
- **R_{ISO}** meter inputs are electronically protected against overloads (caused by e.g. connecting the meter to a live circuit) up to 825 V for 60 seconds.
- Repairs may be performed only by an authorised service point.

ATTENTION!

11 kV DC crocodile clips and probes are designed to work only on objects without voltage.

Note:

Due to continuous development of the meter's software, the actual appearance of the display, in case of some of the functions, may slightly differ from the display presented in this operating manual.

ATTENTION!

To display the correct battery discharge status, it is necessary to completely discharge and then fully charge the battery, before starting the regular use of the meter.

Note:

An attempt to install drivers in 64-bit Windows 8 and Windows 10 may result in displaying "Installation failed" message.

Cause: Windows by default blocks drivers without a digital signature.

Solution: Disable the driver signature enforcement in Windows.

2 Menu

1



Press **MENU** button.

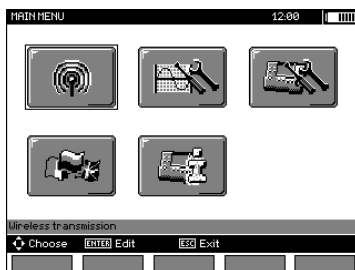



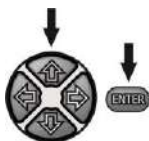

The main menu contains the following items:

- Wireless transmission
- Measurement Settings
- Meter Settings
- Language selection
- Information about manufacturer

2



Use ,  and ,  buttons to select desired position. Enter a selected option by pressing **ENTER**.

2.1 Wireless transmission

See sections 5.3 to 5.5.

2.2 Measurement settings

1

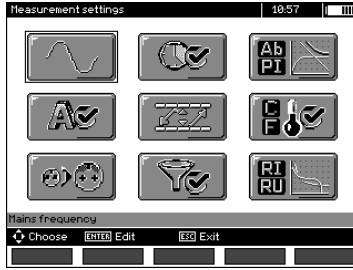



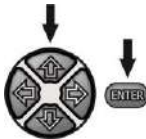

The option of **Measurement settings** consists of:

- Mains frequency
- Times t1, t2, t3 for calculating absorption coefficients
- Absorption coefficients Ab1, Ab2 or DAR PI
- Short-circuit current I_{SO}
- Setting limit values
- Temperature unit
- Cell autoincrementing
- Filter – restricting R_{ISO} display
- Chart type selection

2



Use ,  and ,  buttons to select desired position. Enter a selected option by pressing **ENTER**.

2.2.1 Mains frequency



Only the measurement with a properly selected mains frequency will ensure optimum filtration of interferences. The meter is designed for filtration of interferences generated by 50 Hz and 60 Hz networks.

1

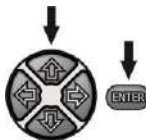

2



Use ,  to select the mains frequency. Confirm your choice by pressing **ENTER** button.

2.2.2 Times t_1 , t_2 , t_3 for calculating absorption coefficients

①

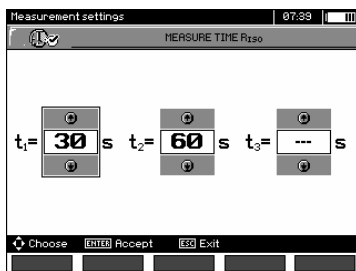

②

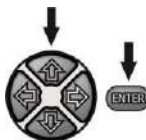

Use \leftarrow , \rightarrow buttons to scroll between times and press \uparrow , \downarrow buttons to set time values. Confirm your choice by pressing **ENTER** button. Selection range: t_1 (1 s...600 s), t_2 (1 s ... 600 s, but $>t_1$), t_3 (1 s...600 s, but $>t_2$).

2.2.3 Type of absorption coefficients

①



②

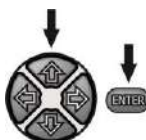

Use \uparrow , \downarrow buttons to select the type of coefficients: Ab or DAR PI. Confirm your choice by pressing **ENTER** button.

2.2.4 I_{ISO} short-circuit current

①

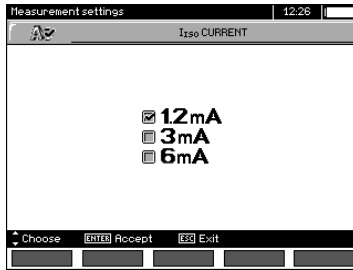

②

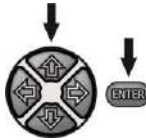

Use **↑**, **↓** buttons to select the current value. Confirm your choice by pressing **ENTER** button.

2.2.5 Setting limit values

①



②

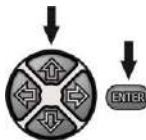

Use **↑**, **↓** buttons to switch on/off limit values. Confirm your choice by pressing **ENTER** button.

2.2.6 Temperature unit

①

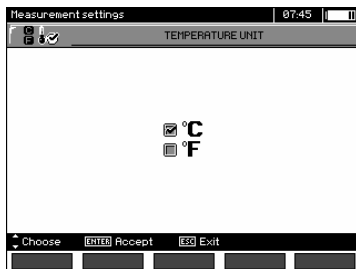

②

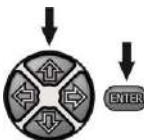

Use **↑**, **↓** to select the temperature unit. Confirm your choice by pressing **ENTER** button.

2.2.7 Auto-incrementing of the memory cell number

①

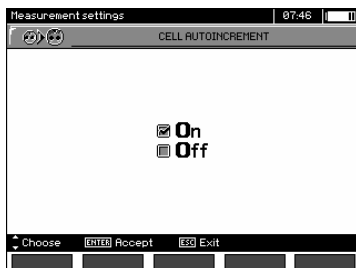

②

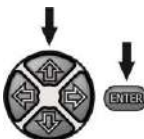

Use **↑**, **↓** to switch on/off the function of Auto-incrementing of the memory cell number. Confirm your choice by pressing **ENTER** button.

2.2.8 Filter

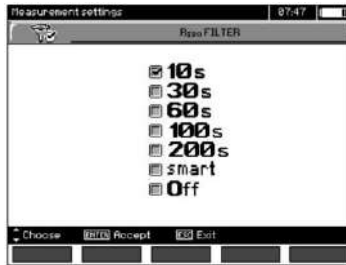

The meter is equipped with advanced digital filters for result stabilisation in difficult and unstable measurement conditions. The meter displays a filtered value of measurements for a specified time period, which may be 10 s, 30 s, 60 s, 100 s, 200 s or, after selecting the **SMART** option, enables the filter which effectively eliminates interference and at the same time quickly determines the result.

1

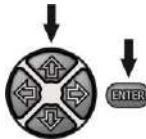

2



Use ,  to select a time period or to switch off the filter. Confirm your choice by pressing **ENTER** button.

Note:

100 s, 200 s and SMART filters are supported only in meters with specific serial number prefixes. Details in the table below.

Meter name	100 s / 200 s / SMART filter supported	100 s / 200 s / SMART filter not supported
	Serial number prefix	
MIC-5050	KI	EO
MIC-10k1	JN, KH	EN

2.2.9 Chart type selection

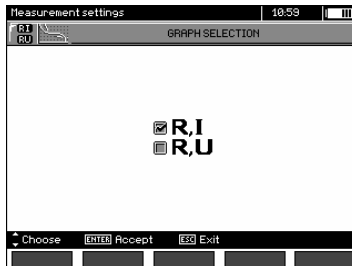

To illustrate the measurement results on the chart, you may select current and resistance (R, I) or voltage and resistance (R, U).

1

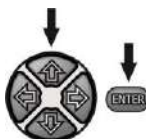

2



Use ,  buttons to select the values to be displayed on the chart. Confirm your choice by pressing **ENTER** button.

2.3 Meter settings

The option of **Meter Settings** consists of:

- LCD contrast
- Automatic shut-off
- Date and time
- Factory (default) settings
- Program update
- Button tones
- Wireless communication

①

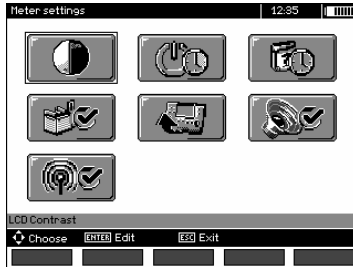

②

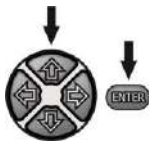

Use **↑**, **↓** and **←**, **→** buttons to select desired position. Enter a selected option by pressing **ENTER**.

2.3.1 LCD contrast

①

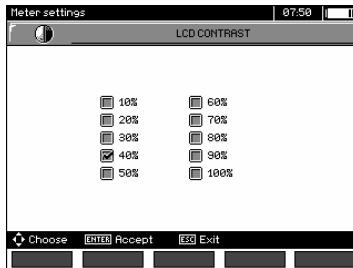

②

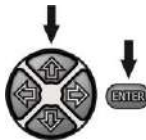

Select contrast value using **↑**, **↓** and **←**, **→** buttons; confirm your choice by pressing **ENTER**.

2.3.2 Automatic shut-off (Auto-OFF)

The setting defines the shut-off time of idle meter.

1

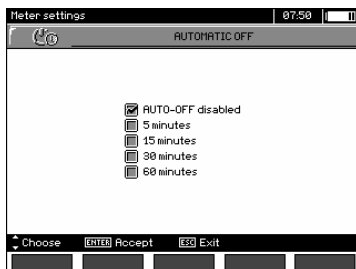

2

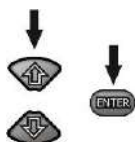

Use **↑**, **↓** buttons to set Auto-OFF time; confirm your choice by pressing **ENTER**.

2.3.3 Date and time

1

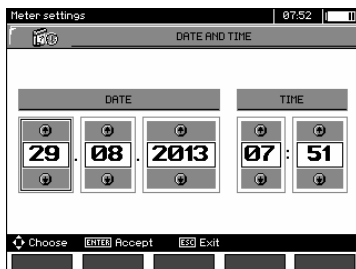

2

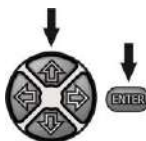

Use **←**, **→** buttons to select the value to be changed (day, month, year, hour, minute). Set a required value using **↑**, **↓** buttons. When required settings are made, press **ENTER**.

2.3.4 Factory (default) settings

①

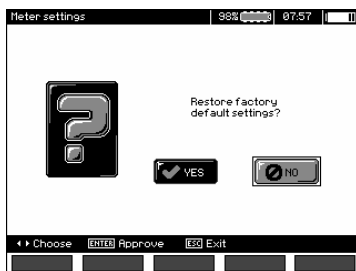

②



In order to introduce factory (default) settings, highlight **YES** using **←**, **→** buttons and press **ENTER** .

Note:

Alternatively, press and hold the ON/OFF button for more than 5 seconds.

2.3.5 Software update

ATTENTION!

Before programming, charge the battery.
During programming the meter must not be switched off as well as the transmission cable must not be disconnected.

1. Before updating the program, download necessary data to a preferred data carrier, because during the updating process all data will be lost.
2. From the manufacturer's website download the meter programming software, unzip the file and install the program on your computer.
3. Run the program and follow the displayed instructions:
 - select **Software update** in MENU of the meter
 - connect the meter to your PC.
4. After displaying the following screen, click **Search** button,



wait until the program finds the meter and click **Start**.



5. After completing the update, disconnect the meter from the computer and click **Close** button.



2.3.6 Key sounds

1



2

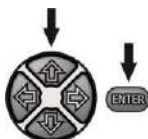

Use **↑**, **↓** buttons to switch on/off key sounds. Confirm your choice by pressing **ENTER** button.

2.3.7 Wireless communication

1



2

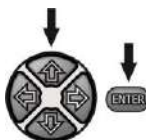

Use **↑**, **↓** buttons to switch on/off wireless communication. Confirm your choice by pressing **ENTER** button.

2.4 Language selection

1



2

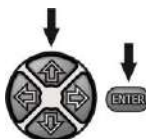

Use **↑**, **↓** buttons to select desired language and press **ENTER**.

2.5 Information about manufacturer

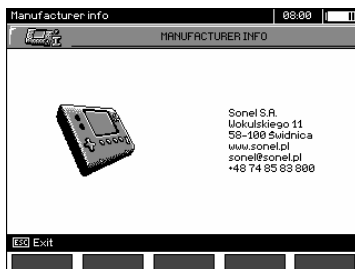

3 Measurements

Notes:

The result of the latest measurement is remembered by the meter until the next measurement is started or the measuring function is changed by means of the rotary switch. The result of the latest measurement is displayed on the screen for 20 seconds. Then it may be recalled by pressing **ENTER**, also after the meter is turned off and turned back on again.

Note:

If a message shown below appears:

Meter temperature is too high! Measurement impossible!

turn the meter off and put it in a place that guarantees cooling.

WARNING:

During a measurement, switching of the range switch is forbidden because it may damage the meter and pose a threat to the user.

3.1 Diagnostics performed by the meter – limits

The meter is able to assess whether the measurement result is within acceptable limits. The user may set a limit, i.e. maximum or minimum value, which should not be exceeded by the result. For measurements of insulation resistance, the set limit is the minimum value, whereas for measurements of continuity of protective conductors and equipotential bonding- it is the maximum value.

The limits are activated globally in the main menu (Section 2.1.5). When the function of setting limits is activated, the display, in its lower left corner, shows the symbols with the following meaning:

- : the result is correct, it is within the set limits,
- : the result is incorrect, it is outside the set limits,

The method for setting limits is described in the chapters describing the measurement data. In DD, SV functions and in after-burning – it is not possible to set limits.

3.2 Measurement of insulation resistance

WARNING:

The tested object must not be live.

Note:

During measurement, especially of high resistances, make sure that test leads do not touch each other and probes (crocodile clips), because such a contact may cause the flow of surface currents resulting in additional error in measurement results.

Inverter output current is limited at 1,2 mA, 3 mA or 6 mA level. Activation of the current limit is indicated by a continuous beep. The measurement result is correct, but on the test terminals the test voltage is lower than voltage selected before the measurement. The current limitation occurs in the first phase of the measurement due to charging the capacity of the tested object.

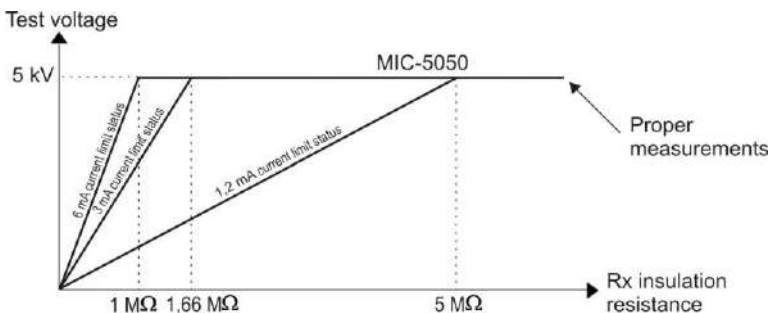
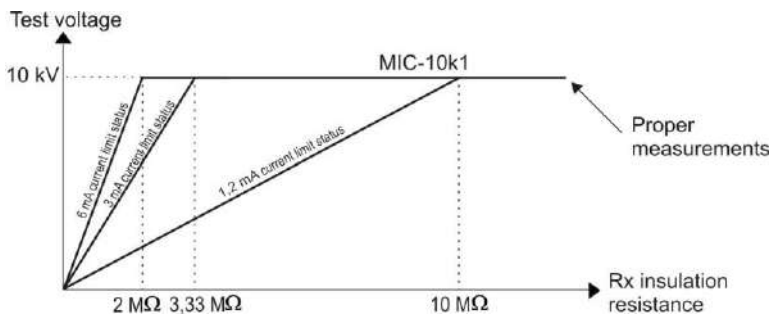

The actual test voltage as a function of the measured insulation resistance R_x (for maximum rated voltage)

3.2.1 Double-lead measurement

①

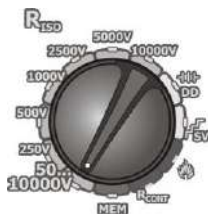

Set the rotary switch of function selection at one of R_{iso} positions, selecting simultaneously measuring voltage:

- for **MIC-10k1** at **50...10000V** voltage is adjusted as follows: 50 V...1 kV in 10V steps, 1 kV...10 kV in 25V steps,
- for **MIC-5050** at **50...5000V** voltage is adjusted as follows: 50 V...1 kV in 10V steps, 1 kV...5 kV in 25V steps.

The meter is in the mode of measuring interference voltage of the tested object U_N .

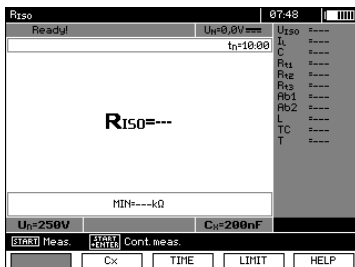

2



To change the measuring voltage, press **F1** **Un** .

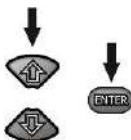

Use **↑**, **↓** buttons to set voltage value; confirm your choice by pressing **ENTER**.

3



To set the measurement time, press **F3** **TIME** .

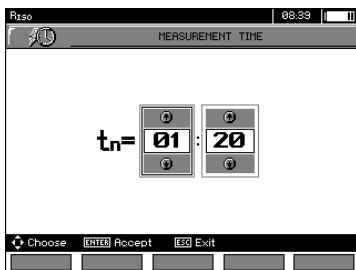

4



To set the capacity of the tested object [nF/km] press **F2**

Cx .

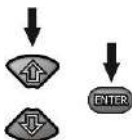
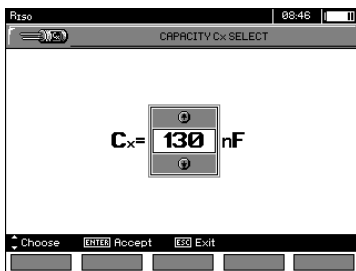

Use **↑**, **↓** buttons to set capacity value; confirm your choice by pressing **ENTER**. The range of changes: from 10 nF to 990 nF. When setting --- (below 10 nF or above 990 nF) the function to calculate the length is switched off.

5



In order to set the limit (minimum resistance), press **F4**

LIMIT

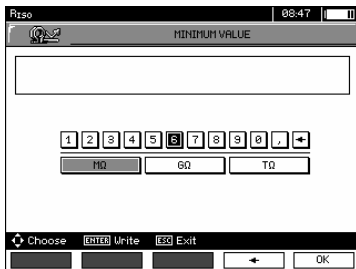

Use **←**, **→** and **ENTER** buttons to enter the resistance value.

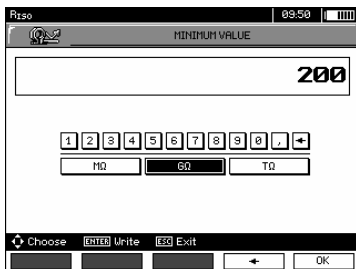

Use **↑**, **↓**, **←**, **→** and **ENTER** buttons to select the unit. Confirm by pressing **F5** **OK**.

For R_{ISO} the limit is the minimum value. The range of setting the limit value is as follows:

- **MIC-10k1** from 1 kΩ to 40 TΩ,
- **MIC-5050** from 1 kΩ to 20 TΩ.

6

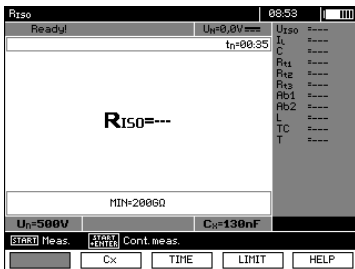

The meter is ready for measurement. Value of interference voltage can be read on the display.

- 7 Connect test leads according to the figure.

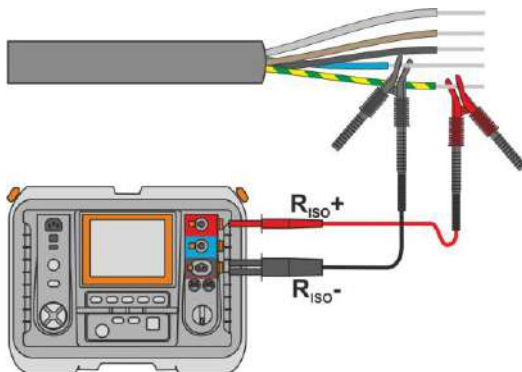

- 8 Press and hold the **START** button for **5 seconds**. After 5 seconds, the measurement **will be started** and continued until **the programmed time is reached** or **ESC** button pressed.





Quick start, without 5 seconds delay, can be done by pressing the **ENTER** button and holding down the **START** button. The measurement will be stopped when the programmed time is reached or the **ESC** button pressed.

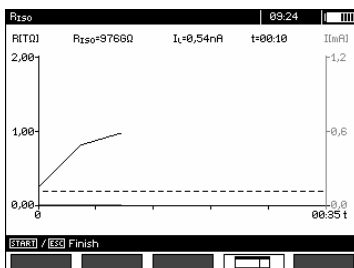

View of the screen during measurement.

- 10 Press **F4**  to display a chart of the measured resistance and current as a function of time.



- When the graph is displayed, press **F4**  to return to the tabular view of the results.

11

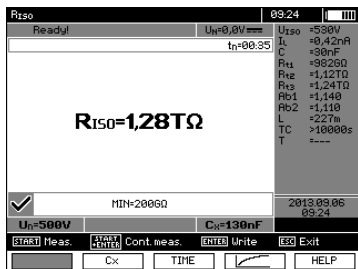

After the measurement is completed, read the result.

12

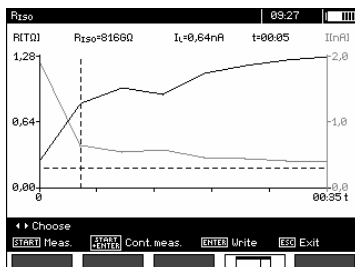

Result presented as a graph. Dashed horizontal line shows the value of set limit. Use \leftarrow , \rightarrow to move the cursor line (vertical dashed line) – the display will show data for the point the set R_{ISO} , I_L and time.

Note:



During measurements of insulation resistance, dangerous voltage up to 10 kV (MIC-10k1) or 5 kV (MIC-5050) occurs at the ends of test leads of the meter.



It is forbidden to disconnect test leads before the measurement is completed. Failure to obey the above instruction will lead to high voltage electric shock and make it impossible to discharge the tested object.

- Disabling t_2 will also disable t_3 .
- Measuring time t_n is independent of the t_1 , t_2 , t_3 times set in MENU and overwrites them i.e. when $t_n < t_3$ then the measurement time will be equal to t_n .
- Timer measuring the measurement time is started when U_{ISO} voltage is stabilized.
- **LIMIT I** message means operation with limited inverter power. If this condition persists for 20 seconds, the measurement is interrupted.
- If any of the measured values of partial resistance is out of range, the value of the absorption coefficient is not displayed – the display shows dashes.
- During the measurement yellow **HV** LED is lit.
- After completion of measurement, the capacitance of the object tested is discharged by shorting R_{ISO+} and R_{ISO-} terminals with resistance of **MIC-5050** 100 kΩ or **MIC-10k1** 200 kΩ. Simultaneously the voltage of the tested object is displayed.
- Capacitance measurement is carried out only while the capacitance of the tested object is being discharged. If the R_{ISO} measurement is interrupted before the R_{ISO} value stabilizes, the discharge will start too early, so the capacitance measurement result may not be correct.

- In case of power cables measure the insulation resistance between each conductor and other conductors shorted and grounded (figure below).

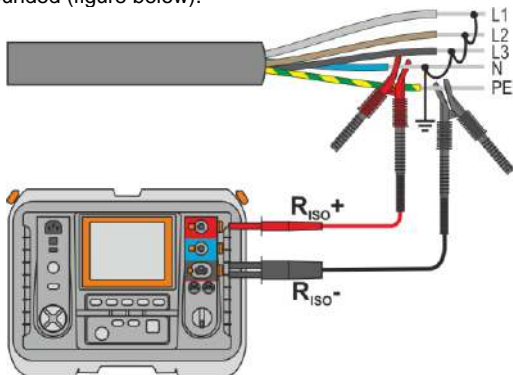

- The length of the cable is calculated on the basis of its capacity on [km] written in before the measurement.

Additional information displayed by the meter

	Test voltage is present on terminals of the meter.
NOISE!	Interference voltage lower than 50 V DC or 1500 V AC is present on the tested object. Measurement is possible but may be burdened with additional uncertainty.
U>50V (U>1500V for AC) + two-tone beep	The tested object is live. The measurement is blocked.
LIMIT I	Activation of current limit. The symbol displayed is accompanied by a continuous beep.
HILE !	Leakage current too high (breakdown of insulation during the measurement.)

3.2.2 Three-lead measurement

In order to eliminate the influence of surface resistance in transformers, cables, etc. the three-lead measurement is used, but do not connect the current measuring test lead R_{ISO-} to large ground conductors. For example:

- at the measurement of inter-winding resistance of a transformer, **G** socket of the meter should be connected to the transformer tank;

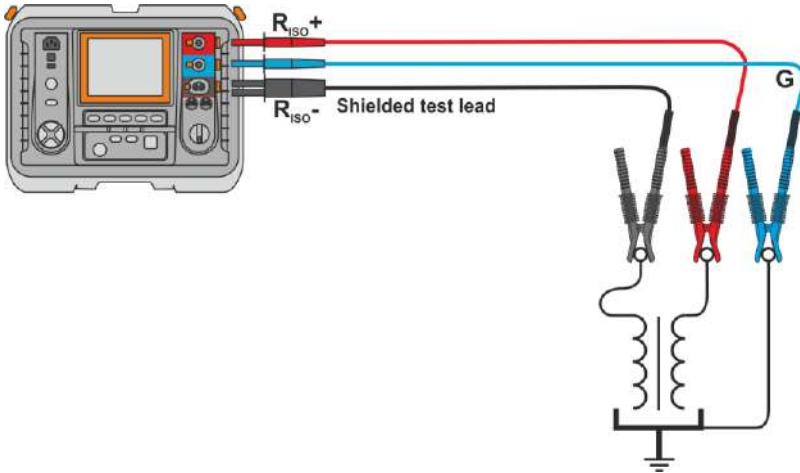

- when measuring the insulation resistance between one of the windings and the transformer's tank, connect **G** socket of the meter to the second winding;

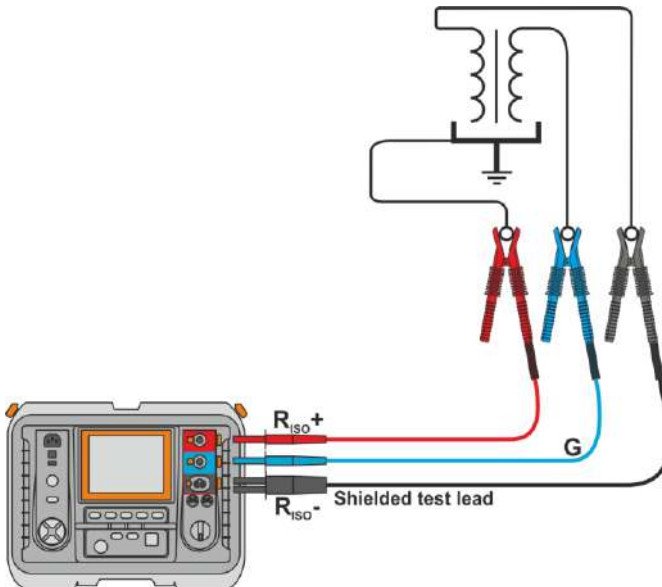

- when measuring insulation resistance between one of the cable conductors and the cable jacket, the effect of surface resistances (important in difficult weather conditions) is eliminated by connecting a piece of metal foil insulating the tested conductor with **G** socket of the meter;

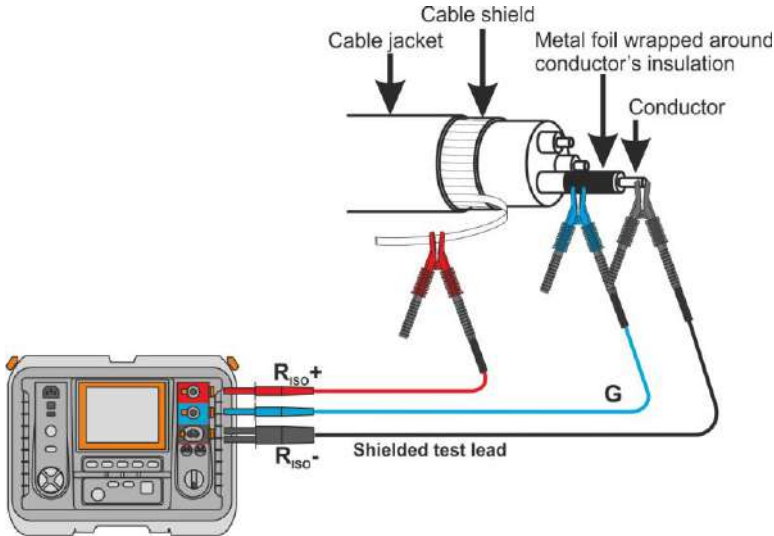

The same shall apply when measuring the resistance between two conductors of the cable, attaching to **G** terminal other conductors that do not take part in the measurement.

- at the measurement of insulation resistance of a high voltage circuit breaker, **G** socket of the meter should be connected to the terminals' insulators of the breaker;

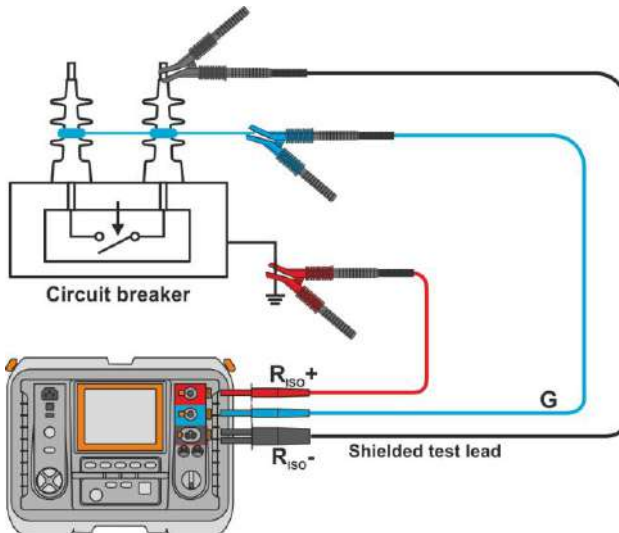

3.2.3 Measurements with AutoISO-5000

1

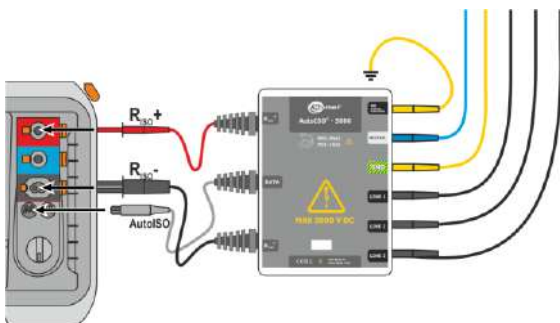

Connect AutoISO-5000 adapter.
The meter detects this fact automatically and changes the appearance of the screen.

2

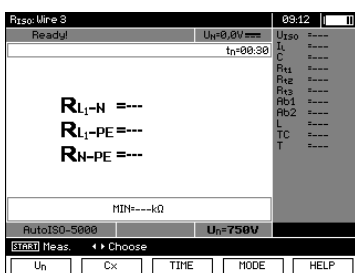

Use **F1** **Un**, **F2** **Cx** and **F3** **TIME** buttons to adjust desired test voltage, capacity of the object and measurement time, similarly as in section 3.2.2

3

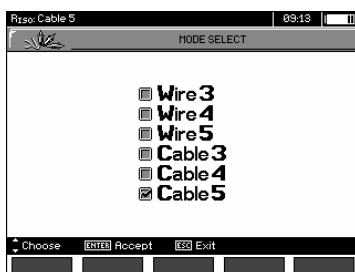

Press **F4** **MODE** button to enter the selection of lead/cable type (3-, 4- or 5-wire lead).



Use **↑**, **↓** buttons to select an appropriate item and confirm it by **ENTER**.

4



Use **←**, **→** buttons, to enter the second group of parameters.

5

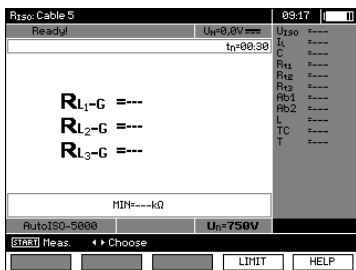

Press **F4** **LIMIT** to set the minimal resistance. It is the same for all conductor pairs of a cable.

6



Use **←**, **→** and **ENTER** buttons to enter the resistance value.

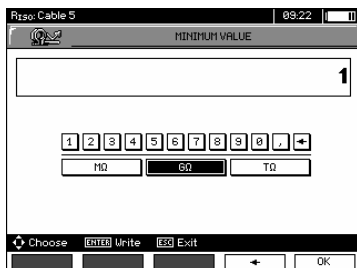

7

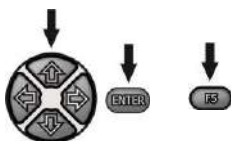

Use **←**, **→**, **↑**, **↓** and **ENTER** buttons to select the unit. Confirm by pressing **F5** **OK**.

8

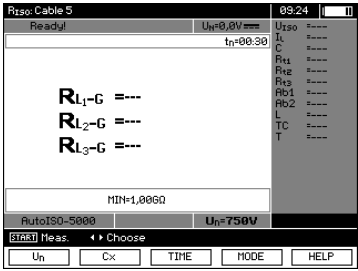

The meter is ready for measurement. Value of interference voltage can be read on the display.

Measurement

9

Connect AutoISO-5000 adapter to the tested cable.

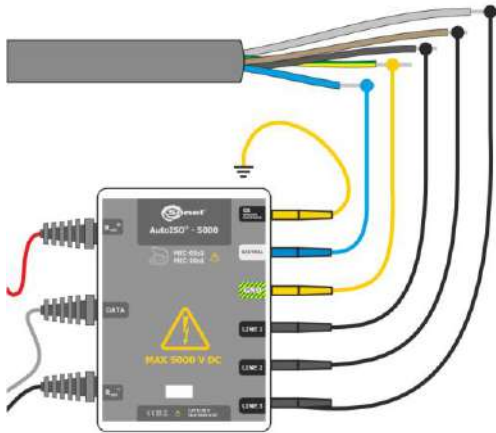

10



Press **START** to start measurement. First, checking of voltages on particular pairs of wires is performed. If any of the voltages exceeds allowable voltage, symbol of this voltage is displayed with "!" (e.g. $U_{N-PE}!$), and the measurement is interrupted.

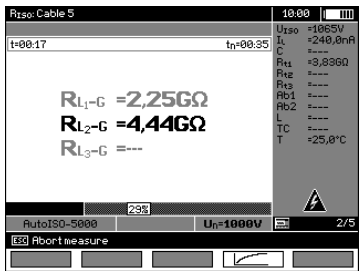

View of the screen during measurement.

11

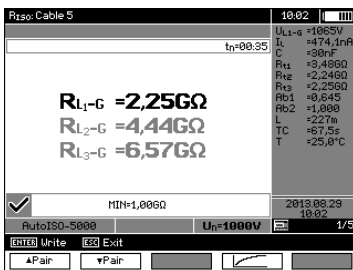

After the measurement is completed, read the results.

12

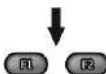

Use **F1 ▲Pair** and **F2 ▼Pair** buttons to change the group of displayed results.

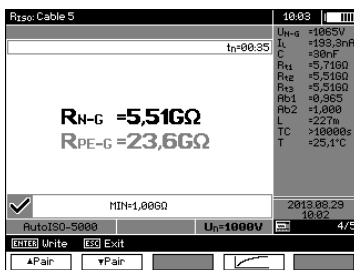

Note:

- Remarks and messages are the same as in 3.2.3.

3.2.4 Measurements with increasing voltage – SV

In this mode the meter performs a series of 5 measurements with increasing voltage; the voltage change depends on the set maximum voltage:

- **1 kV:** 200 V, 400 V, 600 V, 800 V, 1000 V,
- **2.5 kV:** 500 V, 1 kV, 1.5 kV, 2 kV, 2.5 kV,
- **5 kV:** 1 kV, 2 kV, 3 kV, 4 kV, 5 kV,
- **MIC-10k1 10 kV:** 2 kV, 4 kV, 6 kV, 8 kV, 10 kV.

The end result for each of the 5 measurements is saved which is signalled by a beep and an appropriate icon.

1

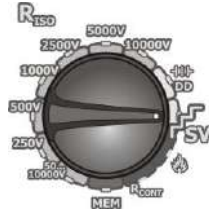

Set the rotary switch of function selection in the **SV** position. The meter is in the voltage measurement mode.

2

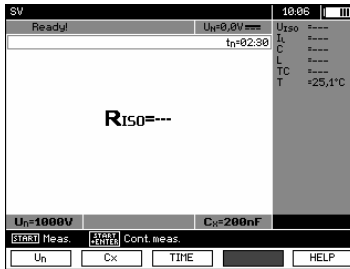

Use **F1** **Un**, **F2** **Cx** and **F3** **TIME** buttons to adjust desired test voltage, capacity of the object and measurement time, similarly as in section 3.2.2

3



Press and hold the **START** button for **5 seconds**. After 5 seconds, the measurement **will be started** and continued until **the programmed time is reached** or **ESC** button pressed.

4



Quick start, without 5 seconds delay, can be done by pressing the **ENTER** button and holding down the **START** button. The measurement will be stopped when the programmed time is reached or the **ESC** button pressed.

5

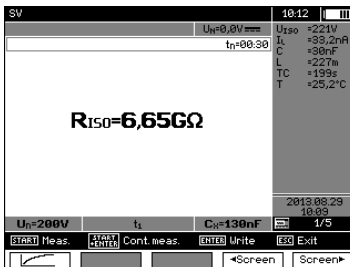

After the measurement is completed, read the result.

6



Use **F4** **Screen**, **F5** **Screen** buttons to switch between consecutive measurements for a given sequence from 1 to 5.

7



Press **F1** to display a chart of the measured resistance and current as a function of time.

Note:

- Other comments and displayed symbols are the same as for standard R_{ISO} measurement.
- In this function, it is also possible to perform the measurement with AutoISO-5000 adapter. The display of results is similar to the measurement of R_{ISO} with AutoISO-5000. The screen will show the following:

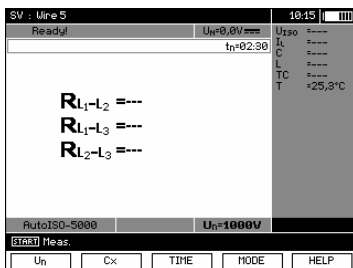

- For the measurement with the AutoISO-5000 adapter, it is not possible to plot the graph during the measurement.

3.2.5 Dielectric Discharge Indicator – DD

In the dielectric discharge test the discharge current is measured after 60 seconds from the end of measurement (charging) of the insulation. The DD is a value characterising the insulation quality independent from the test voltage.

The measurement operates in the following way: first the insulation is charged with a current for a set period. If this voltage is not equal to the set voltage the object is not charged and the meter abandons the measurement procedure after 20 seconds. After the charging and polarisation is complete, the only current flowing through the insulation is the leakage current. Then the insulation is discharged and the total dielectric discharge current starts to flow through the insulation. Initially this current is the sum of the capacity discharge current, which fades quickly and the absorption current. The leakage current is negligible, because there is no test voltage.

After 1 minute from closing the circuit the current is measured. The DD value is calculated using the formula:

$$DD = \frac{I_{1min}}{U_{pr} \cdot C}$$

where:

I_{1min} – current measured 1 minute after closing the circuit [nA],

U_{pr} – test voltage [V],

C – capacitance [μ F].

1

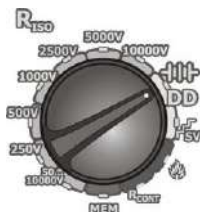

Set the rotary switch of function selection at **DD**. The meter is in the voltage measurement mode.

2

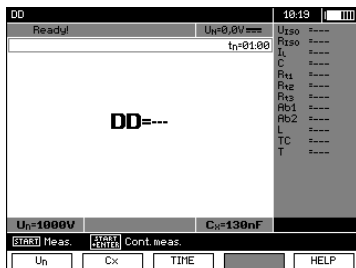

Use **F1 Un**, **F2 Cx** and **F3 TIME** buttons to adjust desired test voltage, capacity of the object and measurement time (1 min ...60 min), similarly as in section 3.2.2

3



Start the measurement, similarly as in section 3.2.4.

4

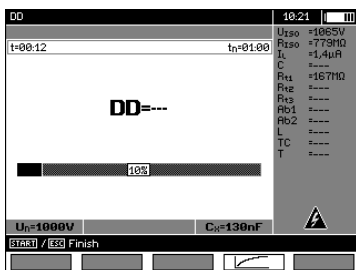

Both during and after the measurement, the user may switch between the display of the results and the graph by pressing **F4**

5

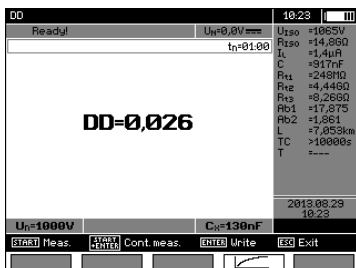

After the measurement is completed, read the result.

6



Press **F4**  to display a chart of the measured resistance and current as a function of time.

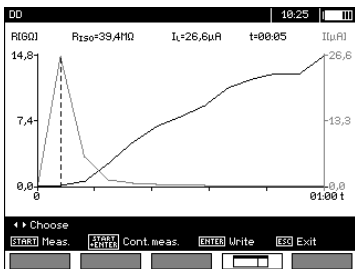

The cursor (i.e. dashed vertical line) may be moved by using **←**, **→** buttons. Measured values are displayed for the point where the cursor is currently positioned. The measurement result indicates the status of the insulation, it may be compared with the following table:

DD value	Insulation condition
>7	Bad
4-7	Weak
2-4	Not the best
<2	OK

Note:

- in an environment with strong interferences the measurement may be affected by additional uncertainty.
- In this function, it is also possible to perform the measurement with AutoISO-5000 adapter. The display of results is similar to the measurement of R_{ISO} with AutoISO-5000. The screen will show the following:

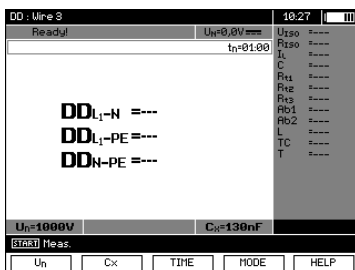

3.2.6 Damage location (after-burning)

The meter carries out the measurement as for R_{ISO} , except that it is not interrupted at the breakdown. In case of a breakdown, the measurement is continued, and the damage may be located as indicated by breakdown sound.

1

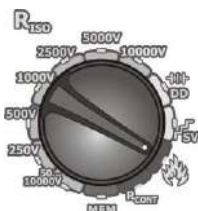

Set the rotary switch of function selection at . The meter is in the voltage measurement mode.

2

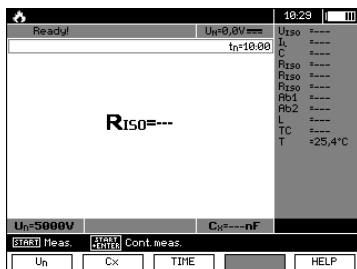

Use F1 **Un**, F2 **Cx** and F3 **TIME** buttons to adjust desired test voltage, capacity of the object and measurement time, similarly as in section 3.2.2

3



Start the measurement, similarly as in section 3.2.2.

4

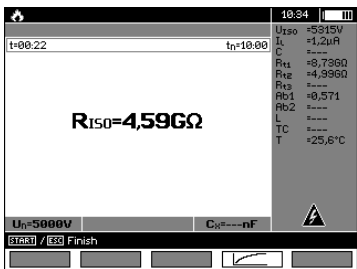

View of the screen during measurement. Both during and after the measurement, the user may switch between the display of the results and the graph by pressing

F4

5



When the insulation breakdown occurs, the meter does not interrupt the measurement (as in other functions) and the display shows (at the top) the corresponding mnemonic.

6

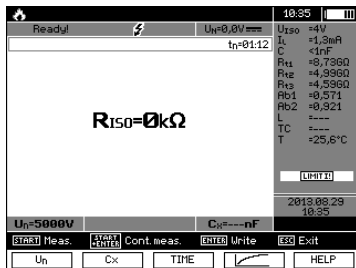

After the measurement is completed, read the result. The display shown after the measurement with insulation breakdown.

7



Press **F4**  to display a chart of the measured resistance and current as a function of time.

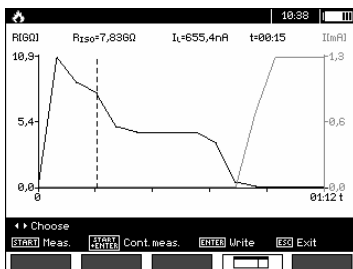

3.3 Low-voltage measurement of resistance

Note:

Low-voltage measurement of resistance (R_{CONT}) is supported only in meters with specific serial number prefixes. Details in the table below.

Meter name	R _{CONT} supported	R _{CONT} not supported
	Serial number prefix	
MIC-5050	B3	EO
MIC-10k1	B4	EN



3.3.1 Measurement of resistance of protective conductors and equipotential bonding with ± 200 mA current

1

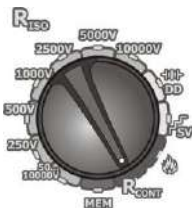

Set the rotary switch at the R_{CONT} position.

2

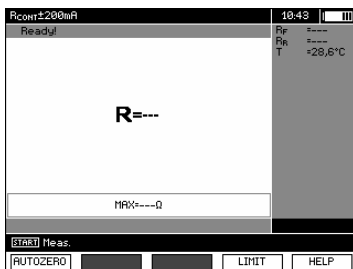

The meter is ready for measurement. Press **F4** **LIMIT** to set the maximum resistance.

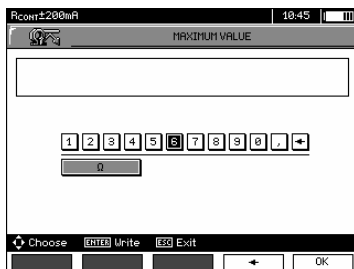

The setting limit reflects the function: from 0.01Ω to 999Ω . The value of the limit set in the same way as for R_{ISO} .

3



Connect the meter to the tested object. Trigger the measurement by pressing the **START** button.

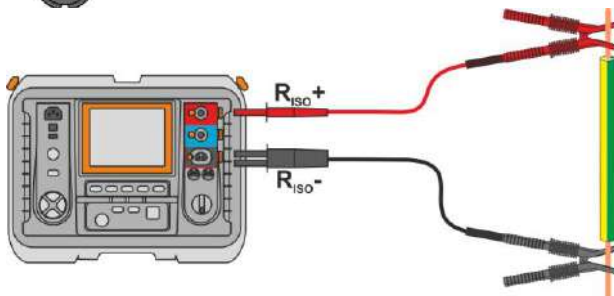

4

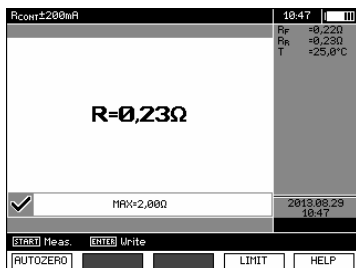

Read out the result.

Additional information displayed by the meter

NOISE!	Interference voltage occurs on the tested object. The measurement is possible however it will be burdened with additional uncertainty that is specified in the technical data.
Voltage on object $U_n > 10\text{ V}$ + two-tone, continuous beep + and LED lit in red	Interference voltage exceeds the allowable value, the measurement is blocked.

3.3.2 Calibration of test leads

In order to eliminate the impact of the resistance of test leads on measurement result, the compensation (autozeroing) of resistance may be performed.

1



2

Follow the instructions displayed on the screen.

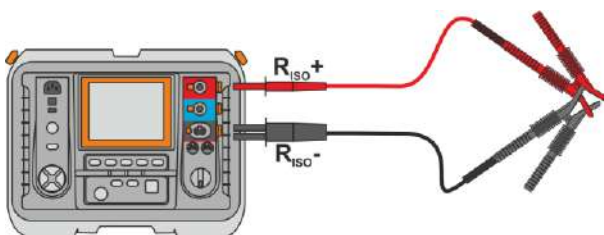

3



Press **START**.

4

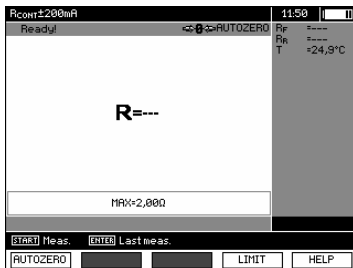

AUTOZERO message appears, confirming that the test leads' calibration has been performed, and the meter enters the measurement mode. **AUTOZERO** message remains visible during measurements. The compensation is active even after the meter is switched off and on again.

5

In order to remove the calibration made (return to default calibration), perform the above-mentioned activities with test leads open.

3.4 Correcting the R_{ISO} value to the reference temperature

The meter has the ability to convert the R_{ISO} measurement value to resistance values at reference temperatures acc. to ANSI/NETA ATS-2009 standard. To obtain such results, the user has to:

- enter the temperature value manually or
- connect the ST-1 temperature probe to the instrument.

Then additional measurement readings will appear.

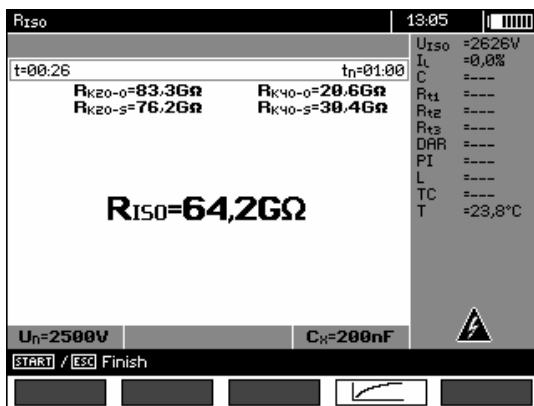

R_{K20-0} – R_{ISO} converted to a value at 20°C for oil insulation (applies i.e. to insulation in **cables**).

R_{K20-S} – R_{ISO} converted to a value at 20°C for solid insulation (applies i.e. to insulation in **cables**).

R_{K40-0} – R_{ISO} converted to a value at 40°C for oil insulation (applies i.e. to insulation in **rotating machinery**).

R_{K40-S} – R_{ISO} converted to a value at 40°C for solid insulation (applies i.e. to insulation in **rotating machinery**).

In order to **set the temperature manually**, press **F1** **Cx / T** ► **F5** **T** and then enter the value as in sec. 3.2.1 step (5). On the other hand, after **connecting the ST-1 probe** the measured value will be displayed in the temperature field.

Temperature measurement commences after connecting the ST-1 temperature probe and it is performed for each function. Values are refreshed every second. After disconnecting the probe, the manually set temperature is displayed again.



To ensure user safety, it is not allowed to mount ST-1 temperature probe on objects with voltage higher than 50 V to earth. It is advisable to ground the examined object before mounting the probe.

3.5 Determining the length of the tested cable

Based on the electrical capacity of the tested object, the device enables the user to determine the length of the tested cable. For this purpose – before starting the measurement – it is necessary to obtain data on the object's parameters (e.g. from the manufacturer's catalogue sheet).

①

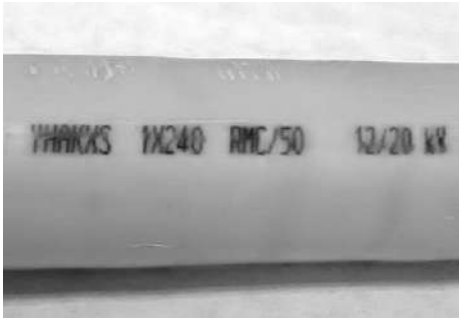

Each cable is marked at 1-metre intervals with the following data:

- ⇒ name of the manufacturer,
- ⇒ cable type,
- ⇒ rated voltage,
- ⇒ number of conductors and cross-section of each of them.

For example, the photograph shows a cable of **YHAKXS 1x240 RMC/50 12/20 kV** type.

②

S mm ²	R (20°C) Ω/km	C µF/km
1x50RMC/16	0,641	0,18
1x70RMC/25	0,443	0,2
1x95RMC/35	0,32	0,22
1x120RMC/50	0,253	0,24
1x150RMC/50	0,206	0,26
1x185RMC/50	0,164	0,28
1x240RMC/50	0,125	0,3
1x300RMC/50	0,1	0,33
1x400RMC/50	0,0778	0,37
1x500RMC/50	0,0605	0,4

Find this cable in the catalogue sheet of its manufacturer. The parameter you search for is **unit capacity**.

Its value should be converted to **nano-farads per kilometre (nF/km)** – the value is entered into the meter in field **C_x**.

In this case the obtained value is **0.3 µF/km = 300 nF/km**.

③

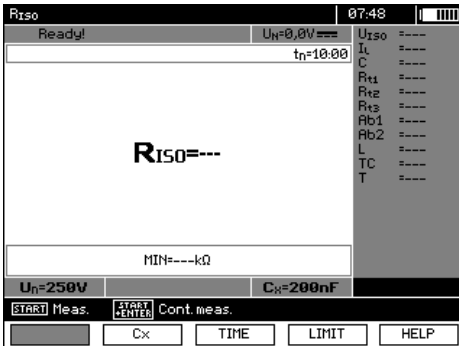

Now you can configure the meter. Use **F2** button to select **C_x**.



4

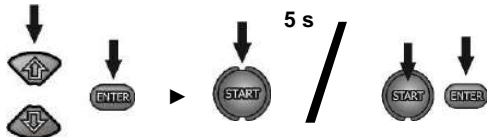
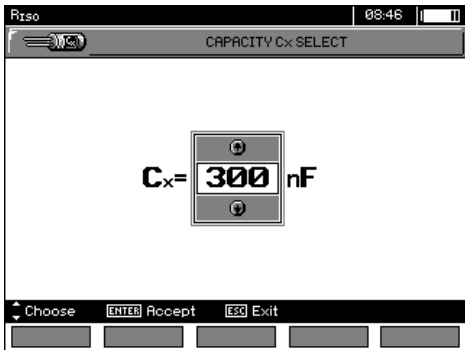

- Use buttons \uparrow \downarrow to set the capacity value. Range of changes: **10...990 nF**. When setting --- (below 10 nF or above 990 nF) the function to calculate the length is switched off.
- Press **ENTER** to confirm the selection.
- Start the measurement.

5

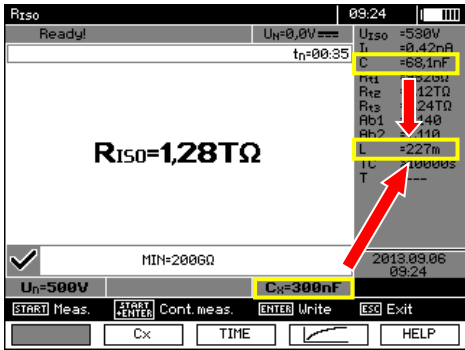

The device measures the total capacity of the cable **C [nF]**. Using this value and when the unit capacity **C_x [nF/km]** is entered, it may calculate the length **L**.

$$C = C_x \cdot L$$

$$L = \frac{C}{C_x}$$

In this case, for:
 C = 68.1 nF
 C_x = 300 nF/km
 the cable length is:

$$L = \frac{C}{C_x} = \frac{68.1 \text{ nF}}{300 \frac{\text{nF}}{\text{km}}} = 0.227 \text{ km} = 227 \text{ m}$$

3.6 Tightness test of MV cable jacket

Tightness test of MV cable jacket consists of applying a test voltage between its metal sheath or its return conductor and the ground. During the measurement, pay attention to the value of I_L current.

The test voltage and the measurement time depend on the type of the tested object and test guidelines. For example, for a cable with polyethylene insulation:

- test voltage according to standard HD 620 S1: $\leq 5 \text{ kV}$,
- measurement time after voltage stabilization: 1-10 min,
- positive result according to HD 620 S1: when no ground fault has occurred.

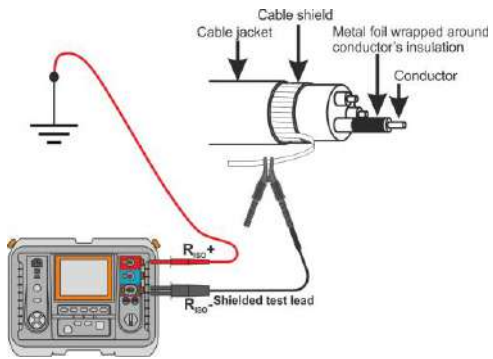

4 Memory of measurement results

4.1 Structure of the Memory

The memory for test results has a tree-like structure (see figure below). The user has the ability to record data for ten clients. Each client may create max. 999 objects, which may store up to three levels of sub-objects, 999 sub-objects for each level. Each subject, and sub-object may store up to 999 measurements.

The whole structure is limited by the size of memory. The memory allows for simultaneous recording of 10 full descriptions of customers, and a minimum of: measurement sets for 10000 measuring points and 10000 names of these points, 999 names for objects, 999 descriptions of sub-objects and remember the layout created for these objects. Additionally the memory has a space for the list of names (selection lists) extended up to 99 entries.

4.1.1 The appearance of main windows in the measurement recording mode

The main folder window

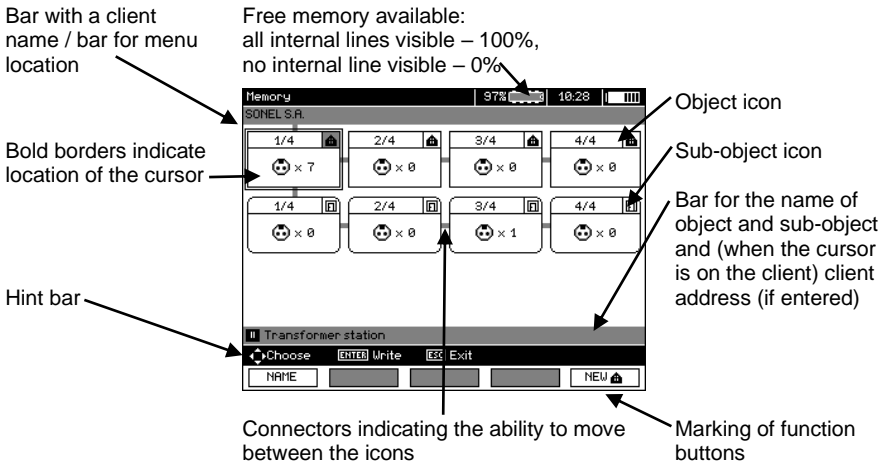

Object without any sub-object

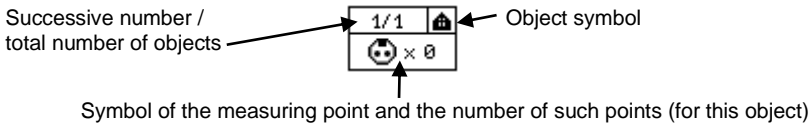

An object containing at least one sub-object

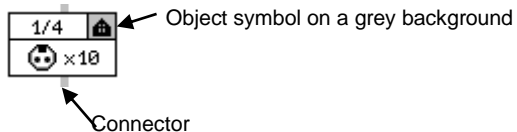

Sub-object without further sub-objects

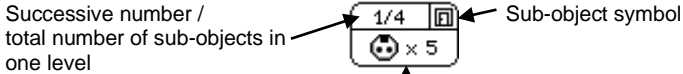

Symbol of the measuring point and the number of such points (for this sub-object)

Sub-object containing more sub-objects

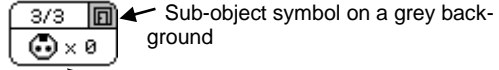

Connector (appears when the cursor is over the icon.)

Client edit window

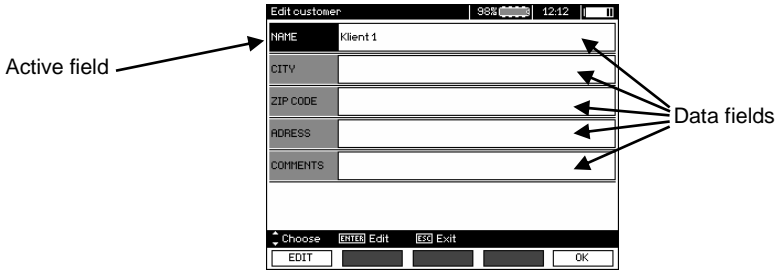

Window for entering a name

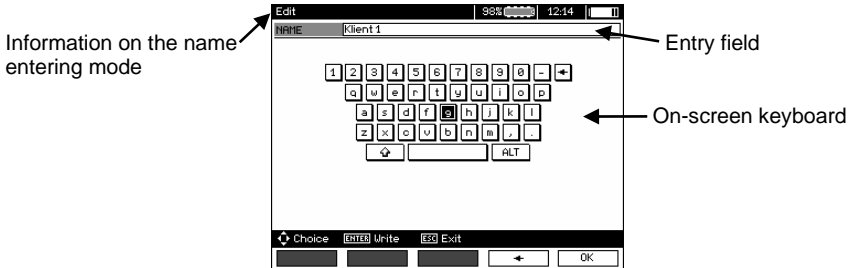

To obtain larger fonts set the cursor on **Shift** and press **ENTER**.

To obtain special (Polish) fonts set the cursor on **ALT** and press **ENTER**.

Window for entering the measurement result

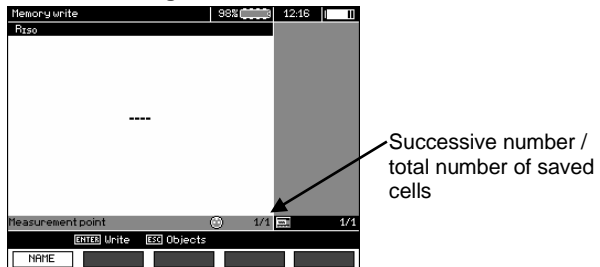

Note:

- Results of measurements performed for all measuring functions can be stored in one memory cell.
- Only the results of the measurements started by pressing **START** key button can be stored in the memory (except autozeroing in low-voltage measurement of resistance).
- Complete set of results (main result and supplementary results) for a given measuring function, pre-set measurement settings, date and time of the measurement are stored in the memory.
- Cells unsaved are not available.
- It is recommended to delete the memory after reading the data or before performing a new series of measurements that may be stored into the same memory cells as the previous ones.
- A single cell may contain either a R_{ISO} 2(3)p measurement result, a R_{ISO} SV, or DD.
- After entering the measurement result, the ID number of the cell is automatically increased.

4.2 Storing the measurement results in the memory



Press **ENTER** after finishing the measurement.

4.2.1 Entering the results without extending the memory structure

①



Press **ENTER** again.





The cell is free for a given type of measurement.

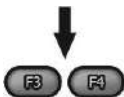

The cell is occupied for a given type of measurement.





Use **F4** **◀Screen**, **F5** **Screen▶** buttons to scroll the components of the result.

② In order to select a measurement point (cell), use , .

③  or  press **ENTER**, to save the result in the memory or **ESC**, to return to displaying the memory structure.

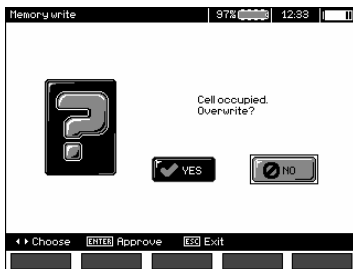
④ If you try to store data in an occupied memory cell, the following warning message will appear:



⑤  or  After selecting **YES** press **ENTER** to overwrite the result or **ESC**, to cancel.

Note:

- Complete set of results (main result and supplementary results) for a given measuring function and preset measurement settings are stored in the memory.

4.2.2 Extending the memory structure



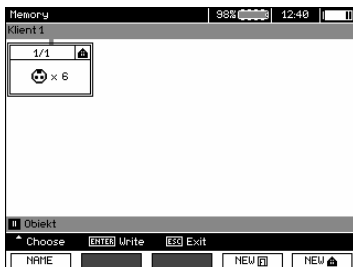

①  Press **ESC** to start creating the objects.



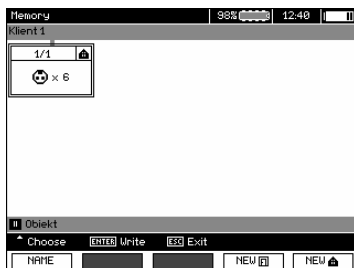

- 2 Press  button to set the cursor on **Client 1**.





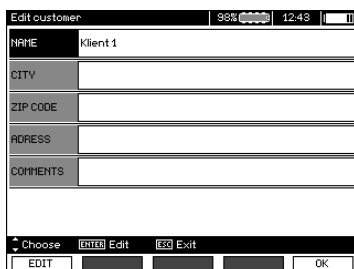

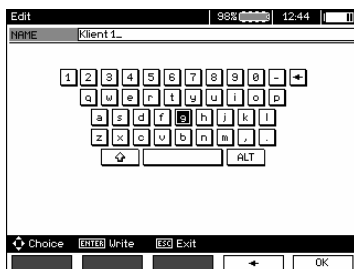

- 3 Use ,  buttons to select other clients (1 – 10).

- 4 Press **F1**  to edit client data.



- 5 Use ,  buttons to set the cursor on each item and press **ENTER** to start the editing.



- 6 Use ,  and ,  buttons to select a character to be typed, and press **ENTER** to enter it.
Press **F4**  to delete typed letters.
Press **F5**  to confirm data and return to the screen of step 4.

7

In this way, you may enter all client data.

Edit customer 98% 12:51

NAME	SONEL S.A.
CITY	Swidnica
ZIP CODE	58-100
ADDRESS	ul. Mokulskiego 11
COMMENTS	

Choose [ENTER] Edit [ESC] Exit

EDIT OK

8

Press **F5** **OK** to confirm data and return to the screen of step 1.

9

Use **↓** button to set the cursor on the object icon. Press **F1** **NAME** to start editing the object name.

Edit 98% 12:52

NAME Obiekt_

1	2	3	4	5	6	7	8	9	0	←	→
a	w	e	t	y	u	i	o	p			
a	s	d	f	g	h	j	k	l			
z	x	c	v	b	n	m					

ALT

Choose [ENTER] Write [ESC] Exit

LIST ← OK

10

Enter the name of the object in the same way as for the customer data. You may use the list of proposed names that is available after pressing **F1** **LIST**. First the list should be created.

1/1 Name list 98% 12:54

1/6 Transformer station
2/6 Transformer
3/6 Electrical substation
4/6 Cable
5/6 Mine
6/6 Engine

Choose [ENTER] Accept [ESC] Exit

NEW DELETE EDIT OK

After pressing **F1** **NEW** you may add further names to the list (up to 99 items), and pressing **F2** **DELETE** deletes the items.

- 11 Press **F5** **OK** to approve the name that appears on the screen.

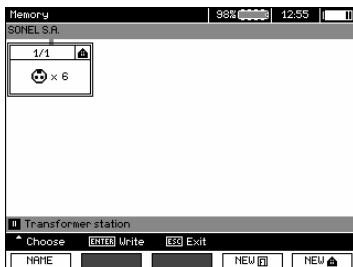

- 12 Press **ENTER**, go to the measurement point.



- 13 Press **F1** **NAME** to enter the editing of the measuring point name.

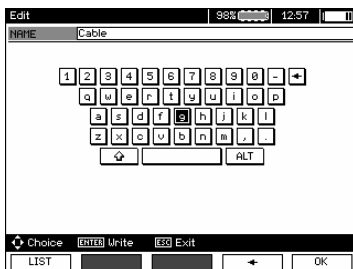

- 14 Enter the name of the measuring point in the same way as the object name.

- 15 press **ENTER**, to save the measurement result.

After entering the memory, the user may extend its structure by adding new objects and sub-objects as needed.

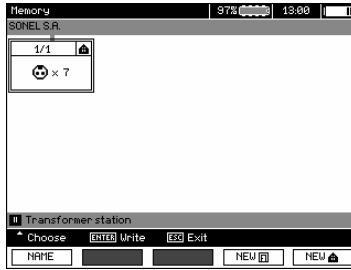

① To add a new object, press **F5** **NEW** .

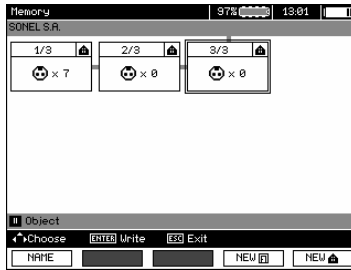

② To add a new sub-object, set the cursor on the chosen object and press **F4** **NEW** .

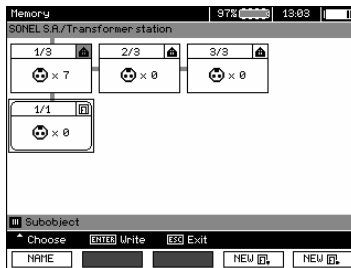

③ Using **F4** and **F5** you may add new objects and sub-objects (up to 5 levels).

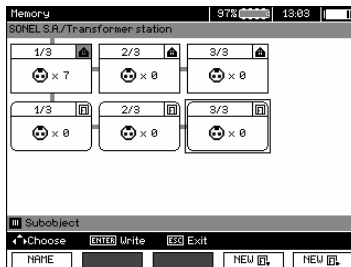

Note:

- New objects (sub-objects in a level) are added on the right side of the object marked with the cursor (sub-object).
- The screen displays only sub-objects belonging to the object (sub-object) indicated by the cursor.
- Deleting objects and sub-objects is possible only in memory browse mode.
- The name of an object, sub-object or measurement is possible in memory browse mode or after entering entry into the memory after a measurement.

4.3 Viewing memory data

1



Set the rotary switch of function selection at **MEM** position.

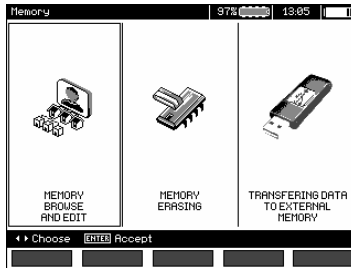

2



Use ←, → buttons to select "**MEMORY BROWSE AND EDIT**".

3



Press **ENTER** button.

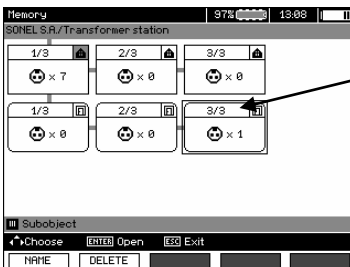

Last saved measurement in sub-object 3, Level 1

4

Use **←**, **→** and **↑**, **↓** buttons to move between objects and sub-objects using the existing connectors.

Press **F1** **NAME** to enter the option for editing the name of object (sub-object) and change it. Press **F2** **DELETE** to delete a chosen object (sub-object) with all its results.

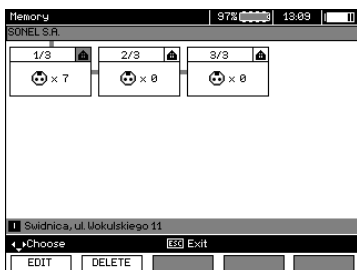

When the cursor is set on "Client", use **←**, **→** buttons to move to next clients.

5



After selecting desired object (sub-object) press **ENTER**.

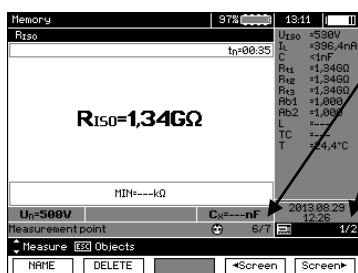

The number of measuring point / number of all measuring points.

The number of measurement type / number of all measurements types at that point.

6

Use **↑**, **↓** buttons to change the measurement point.

Press **F1** **NAME** to enter the editing of the measuring point name and to change it.

Press **F4** **←Screen** or **F5** **Screen▶** to display all individual types of results for a given point.

Press **F2** **DELETE** to delete a chosen measurement or measuring point with all its results:

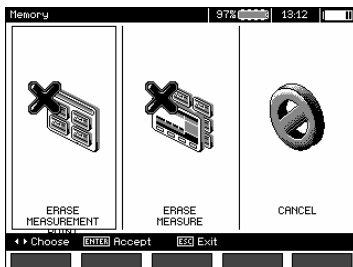

4.4 Deleting memory data

1



Set the rotary switch of function selection at **MEM** position.

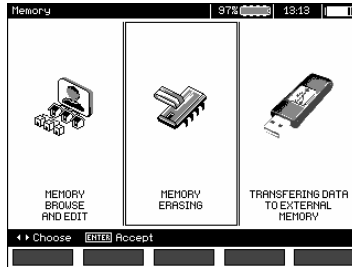

2



Use **↑**, **↓** buttons to select "**MEMORY ERASING**".

3



Press **ENTER** button.

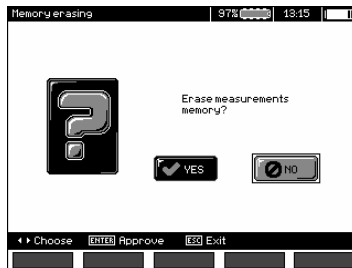

4



Use **←**, **→** buttons to select **YES** or **NO**. Press **ENTER** button.

5 Data transmission

Note:

- Data transmission is not possible while charging the battery.

5.1 Set of accessories to connect the meter to a PC

In order to ensure the communication of the meter with a PC, a USB cable is required or Bluetooth module and appropriate software supplied with the meter.

The software may be used for many devices manufactured by SONEL S.A. which are equipped with the USB interface.

Detailed information is available from the manufacturer and distributors.

5.2 Data transmission through USB port

①

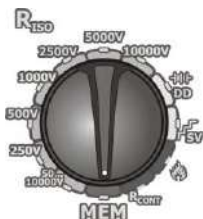

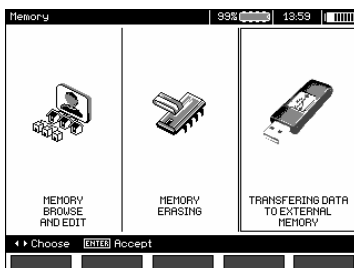

Set the rotary switch of function selection at **MEM** position.



②



Use ,  buttons to select "TRANSFERING DATA TO EXTERNAL MEMORY".

③



Press **ENTER** button.

④

Connect the meter with PC or a USB flash drive using USB cable.

⑤

Start the programme.

5.3 Data transmission using Bluetooth module

1. Activate Bluetooth on your PC (if it is an external module, it must be connected to the computer before). Follow the instructions of the module.
2. Turn on the meter and set the function switch in **MEM**.
3. On a PC enter Bluetooth connectivity mode, select the device (MIC-10k1 / MIC-5050) and establish the connection.
4. If the connection was successful, then the meter will display the following screen:

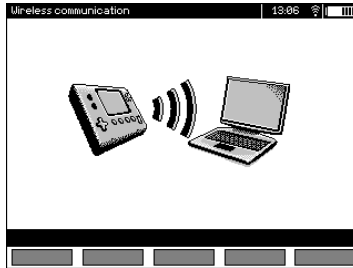

5. Start the software to read /save data (e.g., Sonel Reader, Sonel PE) and proceed in accordance with its instructions.

5.4 Read-out and change of PIN code for Bluetooth connections

Select Wireless transmission in the main MENU of the meter,



press **ENTER**.

Select **CHANGE PIN CODE** position,

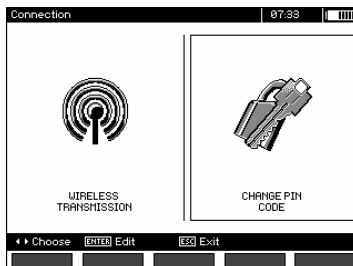

press **ENTER**. Read the current PIN, and change it if necessary, confirming introduced change by pressing **ENTER**.

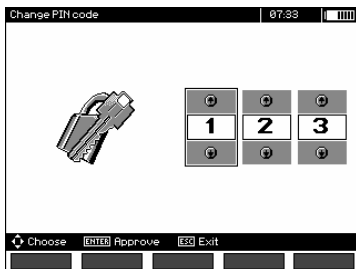

Note:



Standard PIN code for Bluetooth transmission is "123".

6 Power supply of the meter

6.1 Monitoring the power supply voltage

ATTENTION!

To display the correct battery discharge status, it is necessary to completely discharge and then fully charge the battery, before starting the regular use of the meter.

The charge level of the rechargeable battery is indicated by the symbol in the right upper corner of the display on a current basis:



Battery charged.



Battery discharged.



Battery completely discharged.

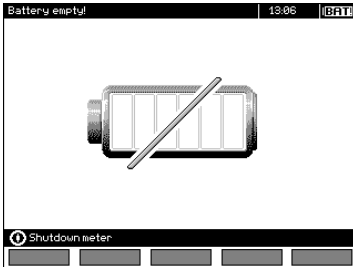

Battery extremely discharged, all measurements are blocked.

6.2 Battery power

MIC-10k1 and MIC-5050 meters are powered with a Li-Ion battery which may be replaced only in a servicing point.

NOTE:

In MIC-10k1 up to SN: B40364 and MIC-5050 up to SN: B30117 gel batteries are used.

The charger is installed inside the meter and works only with the manufacturer's rechargeable battery pack. The charger is powered from the 230 V grid. It is also possible to power the unit from a car lighter using an optional 12 V / 230 VAC converter.

ATTENTION!

Do not power the meter from sources other than those listed in this manual.

6.3 Charging rechargeable battery

Charging commences once the power supply has been connected to the meter regardless of the fact whether the meter is on or off. Charging is indicated by battery symbol being filled and flashing green LED. The rechargeable battery is charged in accordance with the "quick charge" algorithm – this process reduces the charging time to approx. 7 hours. The completion of the charging cycle is indicated by a full battery symbol and the lighting of green LED. In order to turn the device off, unplug the power charger.

Note:

- Due to interferences in the mains, the process of battery charging may finish prematurely. When charging time is too short, turn off the meter and start charging again.

Additional information displayed by the meter



Signalling	Condition
Green LED is flashing (once per second), display shows the battery symbol being filled.	Charging in progress.
Green LED is lit continuously, display shows the full battery symbol.	Charging finished.
Green LED is flashing (twice per second)	Charging error.
Green LED is flashing along with the battery symbol (twice per second), simultaneously  is displayed.	Battery temperature is too high, the measurements are blocked.

6.4 Power supply from mains

It is possible to carry out measurements during the charging process. To activate it, press **ESC** – the meter enters the measurement mode, while remaining in charging mode. Similarly, the process takes place when AC power supply is connected to the meter.

When the meter is turned off by  button or by Auto-OFF, the charging process is not interrupted.

Additional information displayed by the meter

Signalling	Condition
All segments of the battery are flashing once per second.	Charging finished.
Green LED is flashing along with the battery symbol (twice per second), simultaneously  and  are displayed.	Battery temperature is too high.

6.5 General principles for using Li-Ion rechargeable batteries

- Store the half-charged battery pack in a plastic container placed in a dry, cool and well ventilated place and protect them from direct sunlight. The battery pack may be damaged if stored when fully discharged. The ambient temperature for prolonged storage should be maintained within the range of 5°C...25°C.
- Charge the batteries in a cool, well-ventilated place at a temperature of 10°C ... 28°C. Modern fast chargers detect both too low and too high temperature of rechargeable batteries and react to the situation adequately. Too low temperature should prevent starting the process of charging, which might irreparably damage rechargeable batteries. The increase in temperature of the battery pack may cause electrolyte leakage and even its ignition or explosion.
- Do not exceed the charging current, as it may result in ignition or "swelling" of the battery pack. "Swollen" battery pack must not be used.
- Do not charge or use the batteries in extreme temperatures. Extreme temperatures reduce the lifetime of rechargeable batteries. Always observe the rated operating temperature. Do not dispose the battery pack into fire.
- Li-Ion cells are sensitive to mechanical damage. This kind of damage may cause its permanent damage and thus – ignition or explosion. Any interference in the structure of Li-ion battery pack may cause its damage. This may result in the ignition or explosion. A short-circuit of the battery poles "+" and "-" may permanently damage the battery pack or even cause its fire or explosion.
- Do not immerse Li-Ion battery in liquids and do not store in humid conditions.
- If the electrolyte contained in the Lithium-Ion battery pack, contacts eyes or skin, immediately rinse the affected place with plenty of water and consult a doctor. Protect the battery against unauthorised persons and children.
- When you notice any changes in the Lithium-Ion battery pack (e.g. changes in colour, swelling, excessive temperature), stop using the battery pack. Li-Ion batteries that are mechanically damaged, overcharged or excessively discharged are not suitable for use.
- Any misuse of the battery may cause its permanent damage. This may result in the ignition. The seller and the manufacturer shall not be liable for any damages resulting from improper handling Li-Ion battery pack.

6.6 General principles for using gel (lead) rechargeable batteries

- Store the rechargeable batteries in a dry, cool and well ventilated place and protect them from direct sunlight. Do not install them in a tightly closed container. While charging the batteries may produce flammable gases, which may be the cause of explosion if proper ventilation is not available. The best temperature for battery storage and operation is between 15°C and 25°C.
- Do not place batteries near equipment generating sparks, or store them in dusty areas.
- Do not connect the battery to any plastic elements or housing elements containing solvents. This may cause the battery body to unseal or crack.
- During storage of lead batteries they are self-discharged. The storage time without charging is dependent on ambient temperature: from 6 months at 20 °C to 2 months at 40 °C. In order to prevent excessive battery discharge, resulting in a significant reduction of their capacity and durability it is required to recharge them in specified intervals.
- Do not discharge the battery to a voltage below that, specified by its manufacturer. An attempt to recharge an over-discharged battery may cause a thermal hazard, which results in battery deformation or in change of the structure and distribution of the electrolyte in the battery as some of the water evaporates. This worsens the battery parameters similar to prolonged overcharging. Always recharge the battery immediately after discharging, even if it was not discharged to the recommended cut off voltage. Leaving a discharged battery for a couple of hours (sometimes even less than that if the discharge was very deep) will cause sulphating.
- Charging may only be performed using a charger with specific parameters and under the conditions set by their manufacturers. Failure to meet these conditions can lead to leakage, overheating or even an explosion.

7 Cleaning and maintenance

ATTENTION!

Use only the maintenance methods specified by the manufacturer in this manual.

The casing of the meter may be cleaned with a soft, damp cloth using all-purpose detergents. Do not use any solvents or cleaning agents which might scratch the casing (powders, pastes, etc.).

Clean the probe with water and dry it. Before the probe is stored for a prolonged period of time it is recommended to grease it with any machine lubricant.

The reels and test leads should be cleaned with water and detergents, and then dried.

The electronic system of the meter does not require maintenance.

8 Storage

In the case of storage of the device, the following recommendations must be observed:

- Disconnect all the test leads from the meter.
- Clean the meter and all its accessories thoroughly.
- Wind the long test leads onto the reels.
- If meter is to be stored for a prolonged period of time, the batteries must be removed from the device.
- In order to prevent a total discharge of the accumulators in the case of a prolonged storage, charge them from time to time.

9 Dismantling and utilisation

Worn-out electric and electronic equipment should be gathered selectively, i.e. it must not be placed with waste of another kind.

Worn-out electronic equipment should be sent to a collection point in accordance with the law of waste electrical and electronic equipment.

Before the equipment is sent to a collection point, do not dismantle any elements.

Observe local regulations concerning disposal of packages, waste batteries and accumulators.

10 Technical specifications

10.1 Basic data

⇒ The abbreviation "m.v." used in the specification of accuracy denotes a standard measured value

AC/DC voltage measurement

Display range	Resolution	Accuracy
0.0 V...29.9 V	0.1 V	±(2 % m.v. + 20 digits)
30.0 V...299.9 V	0.1 V	±(2 % m.v. + 6 digits)
300 V...1500 V	1 V	±(2 % m.v. + 2 digits)

- Frequency range: 45...65 Hz

Measurement of insulation resistance

Test voltage accuracy ($R_{LOAD} [\Omega] \geq 1000 \cdot U_N [V]$): +10% of the set value

Measurement range acc. to IEC 61557-2:

MIC-5050 $U_N = 5000 \text{ V}: 5.00 \text{ M}\Omega \dots 20.0 \text{ T}\Omega$,

MIC-10k1 $U_N = 10000 \text{ V}: 10.0 \text{ M}\Omega \dots 40.0 \text{ T}\Omega$

Measurement with DC and increasing voltage (SV) for $U_{ISO} = 5 \text{ kV}$

Display range	Resolution	Accuracy
000 k Ω ...999 k Ω	1 k Ω	± (3 % m.v. + 10 digits)
1.00 M Ω ...9.99 M Ω	0.01 M Ω	
10.0 M Ω ...99.9 M Ω	0.1 M Ω	
100 M Ω ...999 M Ω	1 M Ω	
1.00 G Ω ...9.99 G Ω	0.01 G Ω	
10.0 G Ω ...99.9 G Ω	0.1 G Ω	
100 G Ω ...999 G Ω	1 G Ω	± (3.5 % m.v. + 10 digits)
1.00 T Ω ...9.99 T Ω	0.01 T Ω	± (7.5 % m.v. + 10 digits)
10.0 T Ω ...20.0 T Ω	0.1 T Ω	± (12.5 % m.v. + 10 digits)
MIC-10k1 10.0 T Ω ...40.0 T Ω for at $U_N = 10 \text{ kV}$		

- The accuracies shown above are the "worst" values calculated for the top range values. The lower the reading, the higher the accuracy.
- Accuracy for any measuring voltage and each result can be calculated from the following formula:

$$\delta_R = \pm(3 \% + (U_{ISO} / (U_{ISO} - R_{zm} \cdot 21 \cdot 10^{-12}) - 1) \cdot 100 \%) \pm 10 \text{ digits}$$

where:

U_{ISO} – voltage at which the measurement is conducted [V]

R_{zm} – measured resistance [Ω]

Approximate maximum values of the measured resistance, depending on the test voltage, are presented in the table below.

	Voltage	Test range	Measuring range for AutoISO-5000
MIC-10k1 MIC-5050	50 V	200 GΩ	20.0 GΩ
	100 V	400 GΩ	40.0 GΩ
	250 V	1.00 TΩ	100 GΩ
	500 V	2.00 TΩ	200 GΩ
	1000 V	4.00 TΩ	400 GΩ
	2500 V	10.0 TΩ	400 GΩ
	5000 V	20.0 TΩ	400 GΩ
MIC-10k1	10000 V	40.0 TΩ	

⇒ **Note:** For insulation resistance below R_{ISOmin} there is no accuracy specified because the meter works with the adjustable current limit in accordance with the following formula:

$$R_{ISOmin} = \frac{U_{ISOnom}}{I_{ISOnom}}$$

where:

- R_{ISOmin} - minimum insulation resistance measured without limiting the converter current
- U_{ISOnom} - nominal test voltage
- I_{ISOnom} - nominal converter current (1.2 mA, 3 mA or 6 mA)

- Additional error in the three-lead measurement (impact of G terminal): 0.05% with reduced current leakage incurred by 250 kΩ resistance during 100 MΩ measurement with 50 V measurement voltage.
- Max. short-circuit current I_{ISO} : 6 mA ±15 %
- The I_{ISO} current in the remaining load range shall be selected from the following values: 1.2 mA, 3 mA, 6 mA.

Measurement with AutoISO-5000

Display range	Resolution	Accuracy
000 kΩ...999 kΩ	1 kΩ	±(3 % m.v. + 10 digits) of the meter ± 1 % additional error of AutoISO-5000
1.00 MΩ...9.99 MΩ	0.01 MΩ	
10.0 MΩ...99.9 MΩ	0.1 MΩ	
100 MΩ...999 MΩ	1 MΩ	
1.00 GΩ...9.99 GΩ	0.01 GΩ	
10.0 GΩ...99.9 GΩ	0.1 GΩ	
100 G...up to the value at which the additional error of AutoISO-5000 is 5%	1 GΩ	±(3 % m.v. + 10 digits) of the meter ± 5 % additional error of AutoISO-5000

Measurement of leakage current

Display range	Resolution	Accuracy
0.01 nA ... 9.99 nA	0.01 nA	± (1.5% m.v. + 2 digits)
10.0 nA ... 99.9 nA	0.1 nA	
100 nA ... 999 nA	1 nA	
1.00 uA ... 9.99 uA	0.01 uA	
10.0 uA ... 99.9 uA	0.1 uA	
100 uA ... 999 uA	1 uA	
1.00 mA ... 9.99 mA	0.01 mA	

Measurement of capacitance

Display range	Resolution	Accuracy
0 nF...999 nF	1 nF	± (5% m.v. + 5 digits)
1.00 µF...49.99 µF	0.01 µF	

- Measurement of capacitance is available only during R_{ISO} measurement (when discharging the object).
- Accuracy of measurement is met for the tested capacitance connected in parallel with a resistance greater than 10 MΩ.
- For measurement voltages below 100 V the measurement error is not specified.
- The cable length L is calculated as C/C_x , measurement accuracy depends on measurement range.
- Time Constant TC is calculated as $R_{iso} \times C$, measurement accuracy depends on measurement range.

Measurement of continuity of protective conductors and equipotential bonding with ±200 mA current

Measuring range according to IEC 61557-4: 0.12 Ω...999 Ω

Display range	Resolution	Accuracy
0.00 Ω...19.99 Ω	0.01 Ω	±(2 % m.v. + 3 digits)
20.0 Ω...199.9 Ω	0.1 Ω	
200 Ω...999 Ω	1 Ω	±(4 % m.v. + 3 digits)

- Voltage at open terminals: 4 V...24 V
- Output current at $R < 15 \Omega$: min. 200 mA ($I = 200 \text{ mA} \dots 250 \text{ mA}$)
- Current flowing bidirectionally, average resistance is displayed on the screen,
- Compensation of test leads resistance, autozeroing.

Temperature Measurement

Display range	Resolution	Accuracy
-40.0...99.9 °C	0.1 °C	±(3% m.v. + 8 digits)
-40.0...211.8 °F	0.1 °F	±(3% m.v. + 16 digits)

10.2 Other technical data

- a) type of insulation acc. to EN 61010-1 and IEC 61557double
- b) measurement category acc. to EN 61010-1 IV 600 V (III 1000 V)
- c) ingress protection acc. to EN 60529
 - open enclosure IP40
 - closed enclosure IP67
- d) power supply of the meter
 - mains 90 V + 260 V 50 Hz/60 Hz, 200 VA
 - MIC-5050 up to serial number B30117gel rechargeable battery 12 V 5.0 Ah
 - MIC-5050 serial number prefix B3 (from B30118)..... Li-Ion rechargeable battery 14.8 V 5.3 Ah
 - MIC-5050 up to serial number prefix LZ..... Li-Ion rechargeable battery 13.2 V 5.0 Ah
 - MIC-10k1 up to serial number B40364.....gel rechargeable battery 12 V 5.0 Ah
 - MIC-10k1 from serial number B40365gel rechargeable battery 14.8 V 5.3 Ah
 - MIC-10k1 serial number prefix EN, KH Li-Ion rechargeable battery 14.8 V 5.3 Ah
 - MIC-10k1 serial number prefix M1 Li-Ion rechargeable battery 13.2 V 5.0 Ah
- e) dimensions 390 x 308 x 172 mm
- f) meter weight
 - with gel batteryapprox. 7 kg
 - with Li-Ion battery 14,8 Vapprox. 5.6 kg
 - with Li-Ion battery 13,2 Vapprox. 6.1 kg
- g) storage temperature -25°C...+70°C
- h) operating temperature -20°C...+50°C
- i) humidity 20%...90%
- j) altitude (above sea level) ≤3000 m
- k) reference temperature +23°C ± 2°C
- l) reference humidity 40%...60%
- m) display LCD, graphical
- n) number of R_{ISO} measurements, acc. to EN 61557-2 with battery power supplymin. 1000
- o) time of operation on a single battery charge
 - MIC-5050 for $R_{ISO}=5\text{ M}\Omega$, $U_{ISO}=5\text{ kV}$, $T=(23\pm 5)^{\circ}\text{C}$ ca. 5 h
 - MIC-10k1 for $R_{ISO}=5\text{ M}\Omega$, $U_{ISO}=5\text{ kV}$, $T=(23\pm 5)^{\circ}\text{C}$ ca. 4.5 h
- p) memory of measurement results..... 990 cells (10 000 records / 8 MB)
- q) quality standard
 -design, construction and manufacturing are ISO 9001, ISO 14001, ISO 45001 compliant
- r) the device meets the requirements ofEN 61010-1 and IEC 61557 standards
- s) the product meets EMC requirements.....EN 61326-1 and EN 61326-2-2
- t) the rechargeable battery meets the requirements ofEN 62133:2013

ATTENTION!

MIC-10k1 and MIC-5050 meters are classified in terms of Electromagnetic Compatibility (EMC) as instruments of Class A (for use in industrial environments – according to EN 50011). Interferences, impacting the operation of other devices must be taken into account when the meters are used in other environments (e.g. domestic).

Note:

SONEL S.A. hereby declares that the radio device type MIC-10k1/5050 complies with Directive 2014/53/EU. The full text of the EU Declaration of Conformity is available at the following website address: <https://sonel.pl/en/download/declaration-of-conformity/>

10.3 Additional data

Data on additional uncertainties are useful mainly when the meter is used in non-standard conditions and for metrological laboratories for the purpose of calibration.

10.3.1 Additional uncertainties according to EN 61557-2 (R_{ISO})

Significant parameter	Designation	Additional uncertainty
Position	E ₁	0 %
Supply voltage	E ₂	1 % (BAT is not lit)
Temperature 0°C...35°C	E ₃	6 %

10.3.2 Additional uncertainties according to EN 61557-4 (R_{CONT})

Significant parameter	Designation	Additional uncertainty
Position	E ₁	0 %
Supply voltage	E ₂	0.2% (BAT is not lit)
Temperature 0...35°C	E ₃	1 %

11 Manufacturer

The manufacturer of the device and provider of guarantee and post-guarantee service:

SONEL S.A.
Wokulskiego 11
58-100 Świdnica
Poland
tel. +48 74 884 10 53 (Customer Service)
e-mail: customerservice@sonel.com
web page: www.sonel.com

NOTE



Service repairs must be performed solely by the manufacturer.

NOTES

WARNINGS AND GENERAL INFORMATION DISPLAYED BY THE METER

ATTENTION!

Connecting voltage higher than 1500 V, between any of the test terminals may damage the meter and cause a hazard to the user.

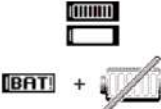
	Test voltage is present on terminals of the meter.
	You must consult the manual.
Ready!	The meter is ready for measurement.
NOISE!	This message displayed during or after the measurement indicates major noise in the system during the measurement. The measurement result may be affected by additional uncertainty.
Voltage on object Un>50V (for DC voltage) or Un~>1500V (for AC voltage) + continuous two-tone beep + red LED flashing	During the measurement, a voltage appeared or the object cannot be discharged for 30 seconds. After 5 seconds the meter returns to its default state - voltmeter.
LIMIT !!	Activation of current limit. The symbol displayed is accompanied by a continuous beep.
HILE !	Breakdown of the tested object insulation, the measurement is interrupted. The message appears after displaying LIMIT !! for 20 s during the measurement, when voltage previously reached the nominal value.
AUTOZERO	Resistance compensation completed for test leads.
Calibration coefficients error	Contact manufacturer's authorised service point to re-calibrate device.
	Battery Status: Fully charged Battery discharged Battery discharged Charge battery.



SONEL S.A.

Wokulskiego 11
58-100 Świdnica
Poland

Customer Service

tel. +48 74 884 10 53
e-mail: customerservice@sonel.com

www.sonel.com